

## D.O.L. Starters In Plastic Enclosure

Ratings AC3 at <b>380V</b> <b>400V</b> <b>415V</b> kW	Included Contactor  Type	Free Space f. Aux. Cont. HN.. pcs.	Wired to accept Overload Relay Type	Protec- tion Degree	Conduit Entries	Type	Coil voltage <sup>1)</sup> 230 220-240V 50Hz 400 380-415V 50Hz	230-264V 60Hz 400-440V 60Hz	Order No	Pack pcs.	Weight kg/pc.
--	-----------------------------------	---	--	---------------------------	--------------------	------	--	--------------------------------	----------	--------------	------------------

## D.O.L. Starters with Start-Stop/Reset Push Buttons



<b>4</b>	K3-10ND10	2	U12/16 K3	IP65	Ø 20,5mm	<b>P1T10</b> . . .				1	0,6
<b>7,5</b>	K3-18ND10	2	U12/16 K3	IP65	Ø 20,5mm	<b>P1T18</b> . . .				1	0,6
<b>11</b>	K3-22ND10	2	U12/16 K3	IP65	Ø 20,5mm	<b>P1T22</b> . . .				1	0,6

## D.O.L. Starters with Selector Switch



<b>4</b>	K3-10ND10	2	U12/16 K3	IP65	Ø 20,5mm	<b>P1W10 400</b>	<b>LA 003 115 K3</b>			1	0,6
<b>7,5</b>	K3-18ND10	2	U12/16 K3	IP65	Ø 20,5mm	<b>P1W18 400</b>	<b>LA 003 116 K3</b>			1	0,6
<b>11</b>	K3-22ND10	2	U12/16 K3	IP65	Ø 20,5mm	<b>P1W22 400</b>	<b>LA 003 117 K3</b>			1	0,6

## D.O.L. Starters with Selector Switch and Pneumatic Switch for moist rooms



<b>7,5</b>	K3-18ND10	2	U12/16 K3	IP65	Ø 20,5mm	<b>P1W18P</b> . . .				1	0,6
------------	-----------	---	-----------	------	----------	---------------------	--	--	--	---	-----

Push button and tube on request

**Ordering Example:** D.O.L. Starter with selector switch, plastic enclosed, rated AC3 at 400V 15,5A, rated control voltage 230V 50Hz - **Order Type:** P1W18 230 + U12/16E 18 K3

## Thermal Overload Relays

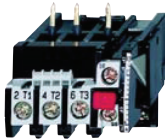

Setting range A	Type	Order No	Pack pcs.	Weight kg/pc.
0,12 - <b>0,18</b>	U12/16E 0,18 K3	LA 300 100 K3	1	0,10
0,18 - <b>0,27</b>	U12/16E 0,27 K3	LA 300 101 K3	1	0,10
0,27 - <b>0,4</b>	U12/16E 0,4 K3	LA 300 102 K3	1	0,10
0,4 - <b>0,6</b>	U12/16E 0,6 K3	LA 300 103 K3	1	0,10
0,6 - <b>0,9</b>	U12/16E 0,9 K3	LA 300 104 K3	1	0,10
0,8 - <b>1,2</b>	U12/16E 1,2 K3	LA 300 105 K3	1	0,10
1,2 - <b>1,8</b>	U12/16E 1,8 K3	LA 300 106 K3	1	0,10
1,8 - <b>2,7</b>	U12/16E 2,7 K3	LA 300 107 K3	1	0,10
2,7 - <b>4</b>	U12/16E 4 K3	LA 300 108 K3	1	0,10
4 - <b>6</b>	U12/16E 6 K3	LA 300 109 K3	1	0,10
6 - <b>9</b>	U12/16E 9 K3	LA 300 110 K3	1	0,10
8 - <b>11</b>	U12/16E 11 K3	LA 300 111 K3	1	0,10
10 - <b>14</b>	U12/16E 14 K3	LA 300 112 K3	1	0,10
13 - <b>18</b>	U12/16E 18 K3	LA 300 113 K3	1	0,10
17 - <b>23</b>	U12/16E 23 K3	LA 300 114 K3	1	0,10
22 - <b>30</b>	U12/16E 30 K3	LA 300 126 K3	1	0,13

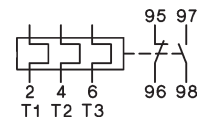

manual reset

## Overload Relays with Quick Tripping Characteristic see page 103

Technical data see contactors page 44 and thermal overload relays page 107

1) Non-standard coil voltages see page 39

## Enclosures for Contactors



Suitable for contactor	Protection Degree	Conduit Entries		Type	Order No	Pack pcs.	Weight kg/pc.
		Top	Bottom				
K3-07.. to K3-22.. K3-24.. <sup>1)</sup> to K3-40.. <sup>1)</sup>	IP65	2 x Ø 20,5mm	2 x Ø 20,5mm	P1	LA 190 181	1	0,35

## Enclosures for D.O.L. Starters with reset button



Suitable for contactor	Protection Degree	Conduit Entries		Type	Order No	Pack pcs.	Weight kg/pc.
		Top	Bottom				
K3-10.. to K3-22.. +U12/16E K3	IP65	2 x Ø 20,5mm	2 x Ø 20,5mm	P1R	LA 190 180	1	0,35

## Indicator Units



Specifications	Voltage Range	Type	Order No	Pack pcs.	Weight kg/pc.
<b>Coil Current Indicator</b> , green (LED)	24 - 660V AC/DC	K2-ING		10	0,02
<b>Coil Current Indicator</b> , red (LED)	24 - 660V AC/DC	K2-INR		10	0,02
To be connected in series with the contactor coil. In case of coil interruption the indicator goes out. Voltage drop approx. 2 volts					
<b>Voltage Indicator</b> , clear (glow-disc. I.)	220 - 415V AC/DC	K2-UN		10	0,02
<b>Voltage Indicator</b> , red (LED)	24 - 120V AC/DC	K2-UNR		10	0,02
To be connected parallel to the contactor coil. In case of applied voltage the indicator also lights at coil interruption.					

### Lens Caps For Indicator Units

Lens cap transparent	LG9743T	10	0,005
Lens cap red	LG9743R	10	0,005
Lens cap green	LG9743GR	10	0,005

Mounting instructions see page 100

## Heating Element



Specifications	Voltage Range	Power Consumption	Type	Order No	Pack pcs.	Weight kg/pc.
To avoid condensed water on places where high humidity is given together with alterations of ambient temperature	380 - 415V	1,5W	K2-HR		10	0,02
	220 - 240V	1,5W	K2-HR 230		10	0,02

## Additional Terminals, Start Contact



Specification	Cable Cross-sections to clamp mm <sup>2</sup>			Type	Order No	Pack pcs.	Weight kg/pc.
	solid or stranded	flexible	flexib. w. multi-core cable end				
<b>Neutral Terminal</b>	2 x 0,75-4	2 x 0,75-2,5	2 x 0,5-2,5	LG9744		10	0,009
<b>Earth Terminal</b>	2,5-16	1,5-10	1,5-10	LG9750		10	0,052
Mounting instructions see page 100							
<b>Start Contact</b>	for contactor K3-10 to K3-22	to be snapped on top of the auxiliary contact		LG9319-K3		10	0,03

<sup>1)</sup> without auxiliary contact blocks

# D.O.L. Starters

## Wiring Diagrams Main Circuit

All fuses F0 shown in the main circuits are not included.  
Terminal markings according to EN 50012

**P1...**  
with overload relay U12/16.. K3

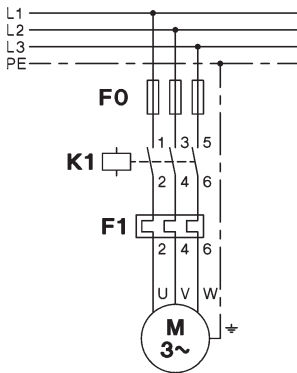

**Wiring for single phase motors**

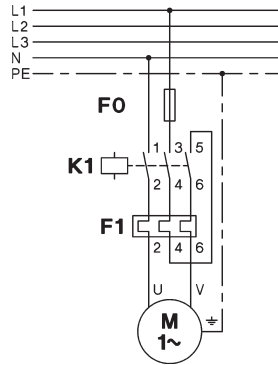

## Wiring Diagrams Control Circuit

D.O.L. Starters P1 with standard coil voltages (see page 94) are supplied with connectors between main circuit and control circuit.

### Coil connectors

Coils for **380-415V 50Hz** and **400-440V 60Hz**: The starter is supplied with control circuit connectors between terminals 1 (L1) and 5 (L3).

Coils for **220-240V 50Hz** and **230-264V 60Hz**: The starter is supplied with control circuit connectors between terminals 95 and 5 (L3). Connect neutral wire to terminal A1.

Coils for **other voltages**: Without connectors between supply and control circuit. Connect supply to terminals A1 and 95.

### Separate coil supply

Coils for **380-415V 50Hz** and **400-440V 60Hz**: Remove connectors A1-1 and 95-5, connect supply to terminals A1 and 95.

Coils for **220-240V 50Hz** and **230-264V 60Hz**: Remove connectors 95-5 connect supply to terminals A1 and 95.

Coils for **other voltages**: Connect supply to terminals A1 and 95.

### Coil phase to phase (380-415V 50Hz)

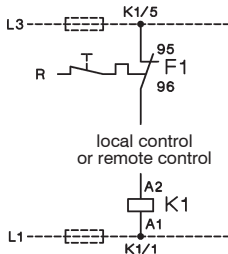

### Coil phase to neutral (220-240V 50Hz)

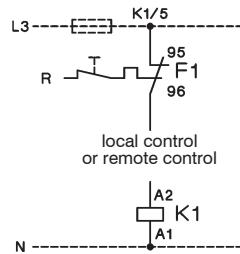

### Coil phase to phase

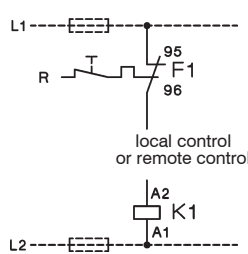

### Coil phase to neutral

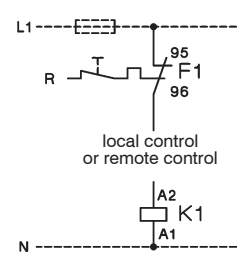

## D.O.L. Starters with remote control

**P1..**  
Remote 2-wire (switch) control

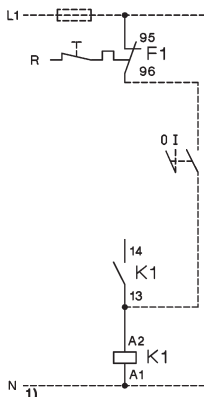

Remote 3-wire (push button) control

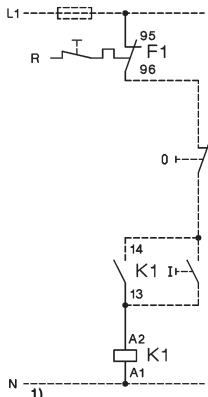

Remote start-stop control  
(3 control stations)

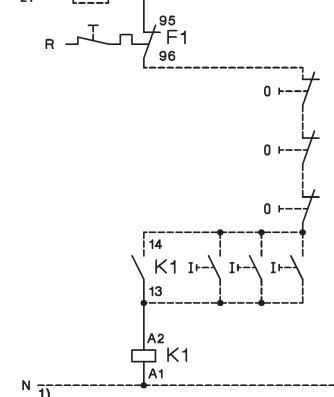

1) "N" Control voltage 230V  
"L3" Control voltage 400V

# D.O.L. Starters

## Wiring Diagrams Control Circuits

Typical circuit diagram (for separate coil supply, control circuit connected between L1 and N)  
Terminal markings according to EN 50012

### D.O.L. Starters with Start-Stop/Reset Push Buttons

**P1T10, P1T18, P1T22**  
with overload relay U12/16.. K3

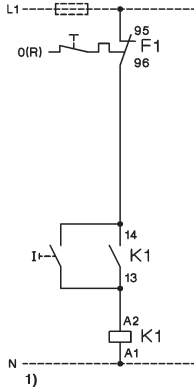

**P1T10, P1T18, P1T22**  
with external push buttons

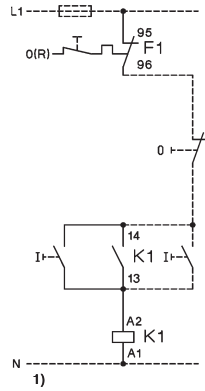

### D.O.L. Starters with Selector Switch

**P1W10, P1W18, P1W22**  
with external control switch

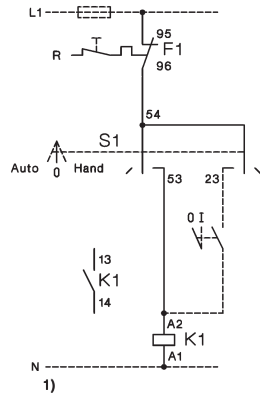

**P1W10, P1W18, P1W22**  
with external push buttons

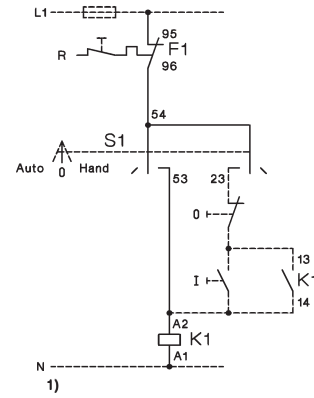

### D.O.L. Starters with Selector Switch and Pneumatic Switch for Swimmingpool Control Gear and for use in Moist Rooms P1W18P

with overload relay U12/16.. K3

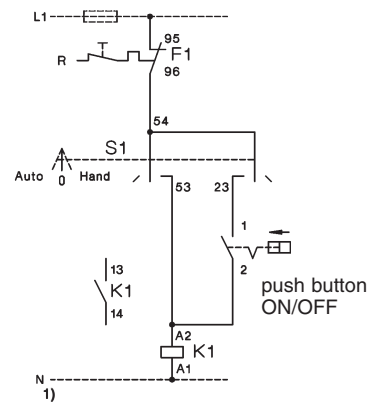

1) "N" Control voltage 230V  
"L3" Control voltage 400V