

SEALED SWITCH MODULE

SELF-CONTAINED, LONG-LIFE, SEALED SWITCH MODULE WITH UP TO 5 POSITIONS

The TC is a self contained, sealed switch module with up to 5 positions. It can be utilized in numerous applications that require a compact switch module and long life.

At slightly over an inch in diameter, it can be used in a grip, front panel, or hand held device, just to name a few applications. It is available in either a top mount or rear mount.

The advantage of the TC switch module is that it incorporates keypad functionality within a very small footprint. Standard or custom legends are available and can be LED backlit.

Standard termination options include FPC, flying leads, ribbon cable (with or without AMP connector) and FFC (flexible flat cable). Tested to three million cycles, the TC switch module has an operating temperature range of -40°C to 85°C and it is sealed to IP68S.

The TC can be used in panel or grip applications and is especially useful in cursor control or data entry applications. Applications include construction, agriculture, industrial, material handling and medical.

Features:

- **Watertight to IP68S**
- **Great for grips and panels**
- **3 million cycle electrical life**
- **LED backlight option**



TC Standard Characteristics/Ratings:	
ELECTRICAL RATINGS:	1-28 VDC @ Sea Level
Load:	10-100mA Resistive
Electrical Life:	3,000,000 cycles
LED Voltage Rating:	2.0 VDC
Mechanical Life:	3,000,000 cycles
Seal:	IP68S
Operating Temp Range:	-40°C to +85°C
Operating Force:	1.0 +/- .5 lbs.
Pushout Force:	5 lbs. min.
MATERIALS:	
Housing:	PBT
Keypad:	Silicone Rubber
Terminal Hardware:	None provided
Mounting Hardware:	VHB tape



TC Switch Module Keypad Configurations

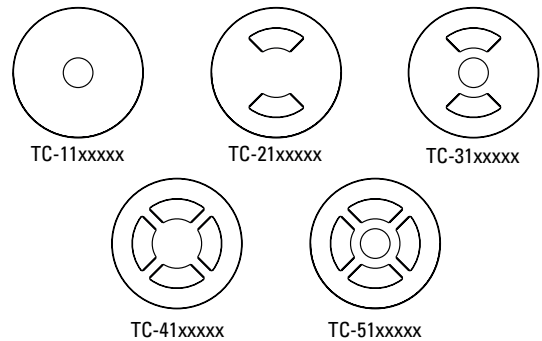

TC PART NUMBER CODE

TC	-	X		X		X		X		X		X
Position		Mounting		Termination		Backlight		Color		Legend*		Not Used
1. 1 Position		1. Top Mount		1. FPC, UL 20798		N. None		2. Black		None		
2. 2 Position		2. Rear Mount (Behind Panel)		2. Flying Leads, UL 1569, 24 AWG		9. White				A. Arrows		
3. 3 Position				3. FFC, UL 20624								
4. 4 Position				4. Ribbon Cable, UL 2651, & AMP 215083-8 Connector								
5. 5 Position				5. Ribbon Cable, UL 2651, Blunt Cut								

Arrow Legend Styles

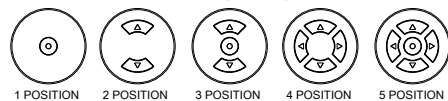

* Color = White

SEALED SWITCH MODULE

SELF-CONTAINED, LONG-LIFE, SEALED SWITCH MODULE WITH UP TO 5 POSITIONS

TC-51xxxxx Top Mount, 5 Position Module

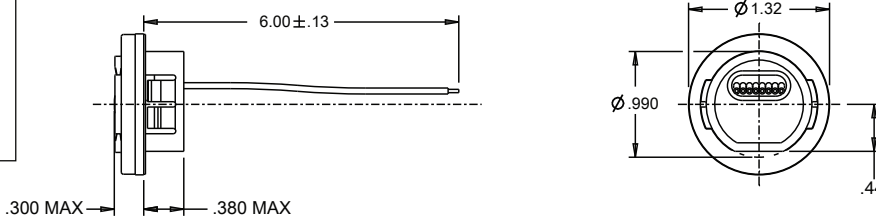
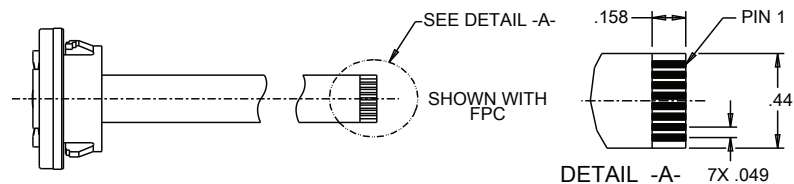
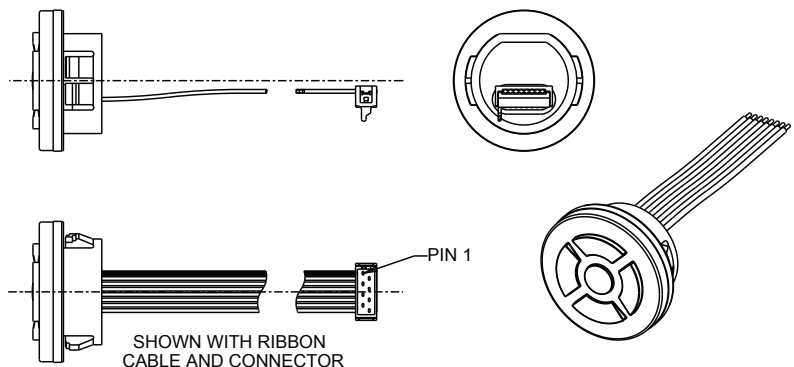
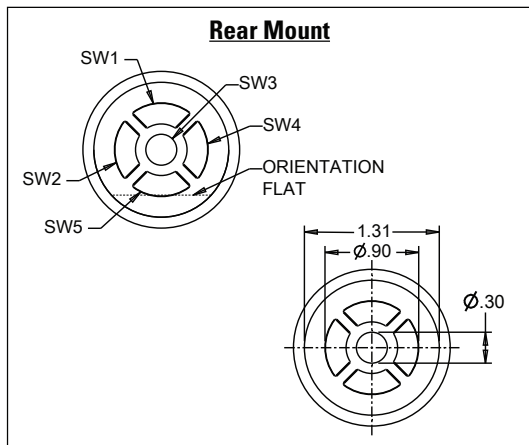
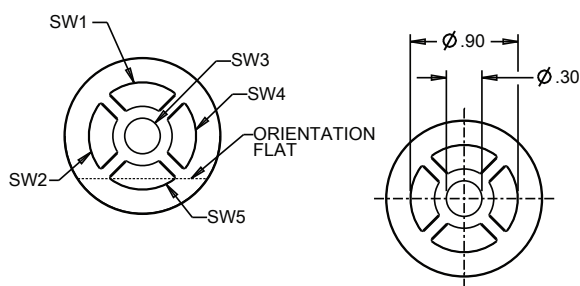

PANEL THICKNESS: ACCOMODATES
PANEL THICKNESSES FROM
.025 TO .100 WITH VHB TAPE SEAL,
AND FROM .025 TO .125 WITHOUT
VHB SEAL TAPE.

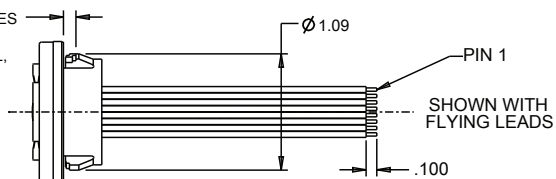

Standard Legend Configurations

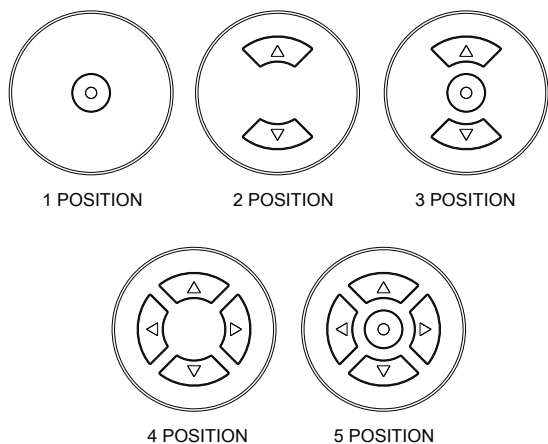

Schematic with optional LED circuit shown

