

SHORTER BEHIND PANEL DEPTH



Knurled Wheel



Paddle Wheel

The HTWM offers the same performance as the standard HTW Proportional Thumbwheel but with a much shorter behind panel depth, ideal for use in grip, armrest and panel applications. Available with eight output options, the HTWM offers a spring return-to-center, single axis thumbwheel actuator that provides linear change in voltage output in either direction from center. Options include increasing or decreasing voltage output from the center position to the full travel position, and single or dual (redundant) outputs per axis. The HTWM offers snap-in style mounting and a three million cycle rotational life. The HTWM electronics are sealed to IP68S and have excellent EMI/RFI immunity.

## Features:

- Shorter behind panel depth: 0.96" max.
- 8 output options
- Spring return-to-center single axis actuator
- Rocker switch style mounting
- 3 million cycle rotational life
- Electronics sealed to IP68S
- Excellent EMI/RFI immunity
- Tighter center tolerance options
- RoHS compliant

### Standard Characteristics/Ratings:

#### MECHANICAL:

**Mechanical Life:** 3,000,000 full forward to full back

**Max Allowable Radial Load:** 30.0 lbs.

**ELECTRICAL RATINGS: Rated at Vcc = 5V @ 25°C Load = 1mA (4.7KΩ)**

Electrical	Units	Min	Typ	Max
Supply Voltage	VDC	4.50	5.00	5.50
Output Voltage Tolerance at Center (A, B, C, D, E, F and G)	VDC @ 5V Vcc	-0.25	N/A	+0.25
Output Voltage Tolerance at Center (J, K, L, M, N and P)	VDC @ 5V Vcc	-0.15	N/A	+0.15
Output Voltage Tolerance at Full Travel	VDC @ 5V Vcc	-0.25	N/A	+0.25
Supply Current Per Sensor	mA	N/A	N/A	10

#### ELECTRONICS:

**Seal Integrity:** Electronics IP68S

#### ENVIRONMENTAL:

**Operating Temp Range:** -40°C to +85°C

**Humidity:** 96% RH, 70°C, 96 hours

**Vibration:** Per MIL-810F minimum integrity

**EMI:** Withstand per SAE J1113

**RFI:** Withstand per SAE J1113

#### MATERIALS:

**Button:** Thermoplastic

**Bezel:** Thermoplastic

**Wires:** 18 AWG or 22 AWG

# MINI PROPORTIONAL OUTPUT THUMBWHEEL

SHORTER BEHIND PANEL DEPTH

## HTWM PART NUMBER CODE

HTWM	-	X	X	X	X	X	X	X
Travel	Output 1*	Output 2**	Operating Force	Button Style	Termination	Bezel Color	Button Color	
1. +/- 40°	A. 2.5 +/- 2.0VDC	NONE	1.5.0 oz.	1. Knurled Wheel	A. 18 AWG Wires, 18.3" Long, Stripped Ends	1. Red	1. Red	
	B. 2.5 +/- 2.0VDC	2.5 +/- 2.0VDC		2. Paddle Wheel	C. 22 AWG Wires, 18.5" Long, Stripped Ends	2. Black	2. Black	
	C. 2.5 +/- 2.0VDC	2.5 -/+ 2.0VDC				3. Orange	3. Orange	
	D. 2.5 +/- 1.5VDC	NONE				4. Yellow	4. Yellow	
	E. 2.5 +/- 1.5VDC	2.5 +/- 1.5VDC				5. Green	5. Green	
	F. 2.5 +/- 1.5VDC	2.5 -/+ 1.5VDC				6. Blue	6. Blue	
	G. 1.0 - 4.0VDC	1.0 - 4.0VDC				7. Violet	7. Violet	
	H. 0.5 - 4.5VDC	0.5 - 4.5VDC				8. Gray	8. Gray	
	J. 2.5 +/- 2.0VDC	NONE***				9. White	9. White	
	K. 2.5 +/- 2.0VDC	2.5 +/- 2.0VDC***						
	L. 2.5 +/- 2.0VDC	2.5 -/+ 2.0VDC***						
	M. 2.5 +/- 1.5VDC	NONE***						
	N. 2.5 +/- 1.5VDC	2.5 +/- 1.5VDC***						
	P. 2.5 +/- 1.5VDC	2.5 -/+ 1.5VDC***						

\* Outputs are from the center position to the full travel position in each direction. Options A-F provide increasing voltage in Direction 1 and decreasing voltage in Direction 2 from a single output. Options G and H provide increasing voltages in both directions from two separate outputs.

\*\* Options B and E provide redundant output 2 which duplicates output 1. Options C and F provide redundant output 2 which is inverse of output 1.

\*\*\* Options J, K, L, M, N and P are identical to options A, B, C, D, E and F respectively, except with a tighter center tolerance.

### HTWM Knurled Wheel Style Thumbwheel Shown

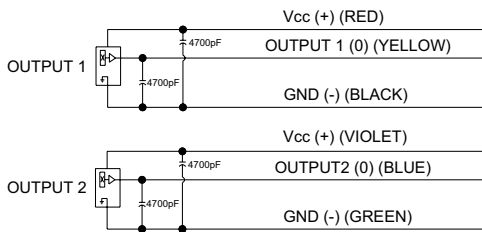
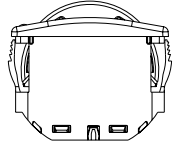
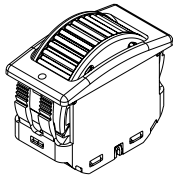

OUTPUT 2 IS NOT PRESENT IN ALL CONFIGURATIONS

#### MOUNTING:

RECOMMENDED PANEL THICKNESS: 0.150 OPTIMUM THICKNESS  
(0.040 MIN. - 0.200 MAX.)

RECOMMENDED PANEL OPENING: 0.700 X 1.340 OPTIMUM  
(0.695/0.705 X 1.335/1.345)

RECOMMENDED PANEL RADII: 0.100 OPTIMUM  
(0.090 - 0.110 MAX.)

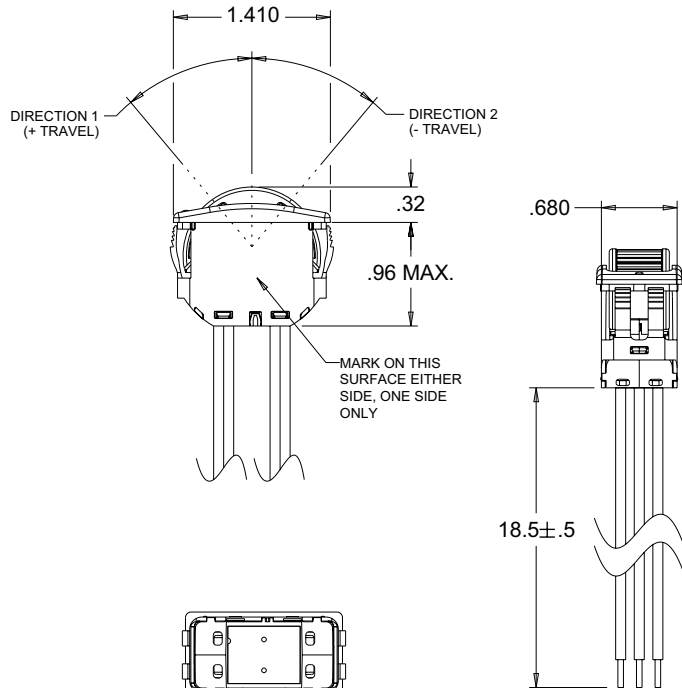
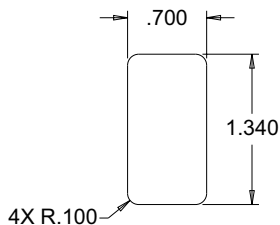

NOT ALL WIRES ARE PRESENT  
IN ALL OUTPUT CONFIGURATIONS

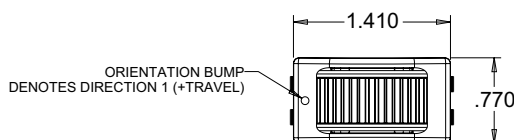

SHORTER BEHIND PANEL DEPTH

**OPTION A & J**

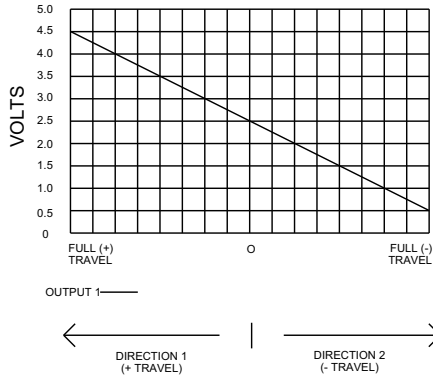

**OPTION B & K**

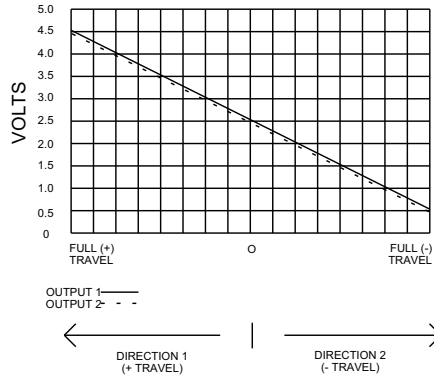

**OPTION C & L**

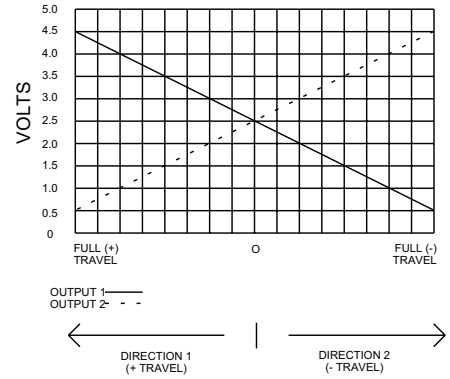

**OPTION D & M**

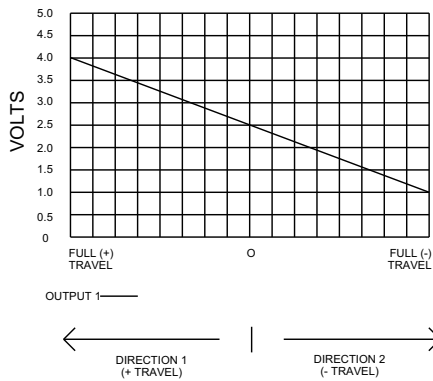

**OPTION E & N**

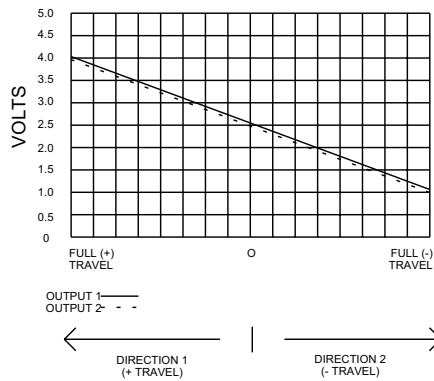

**OPTION F & P**

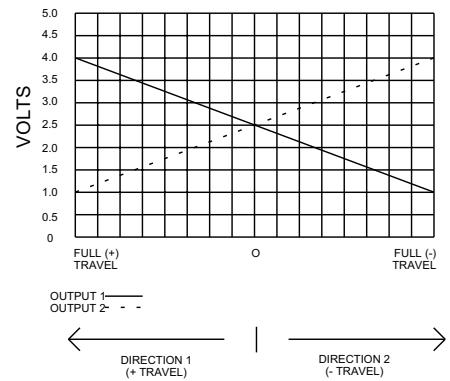

**OPTION G**

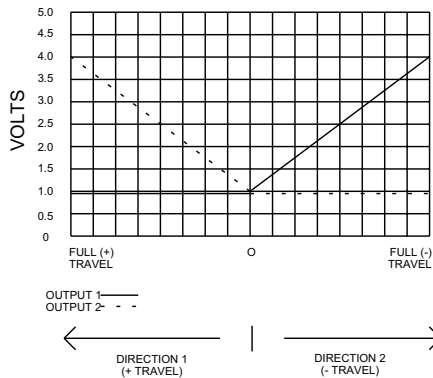

**OPTION H**

