

SPECIFICATIONS:

CONTACT RATING: 16A 125/250VAC.
 ELECTRICAL LIFE: 10,000 cycles min. at full load.
 CONTACT RESISTANCE: Max. 300mΩ.
 INSULATION RESISTANCE: 500VDC 100M-ohms min.
 DIELECTRIC STRENGTH: 1,500VAC for 1 minute.
 OPERATING TEMPERATURE: -30°C to +85°C.

MATERIALS:

BUTTON: Stainless steel.
 BUSHING: Stainless steel with threaded bushing.
 BODY: NYLON 6/6 (UL 94V-0).
 O-RING: Silicone.
 INTERMEDIATE CONNECTOR: POM.
 ILLUMINATION PART: PC.
 CONTACT: Silver alloy.
 TERMINAL: Brass silver plated.

Specifications and Dimensions subject to change

If your preferred product configuration is not shown, please contact our sales representative for custom design.

HOW TO ORDER SYSTEM

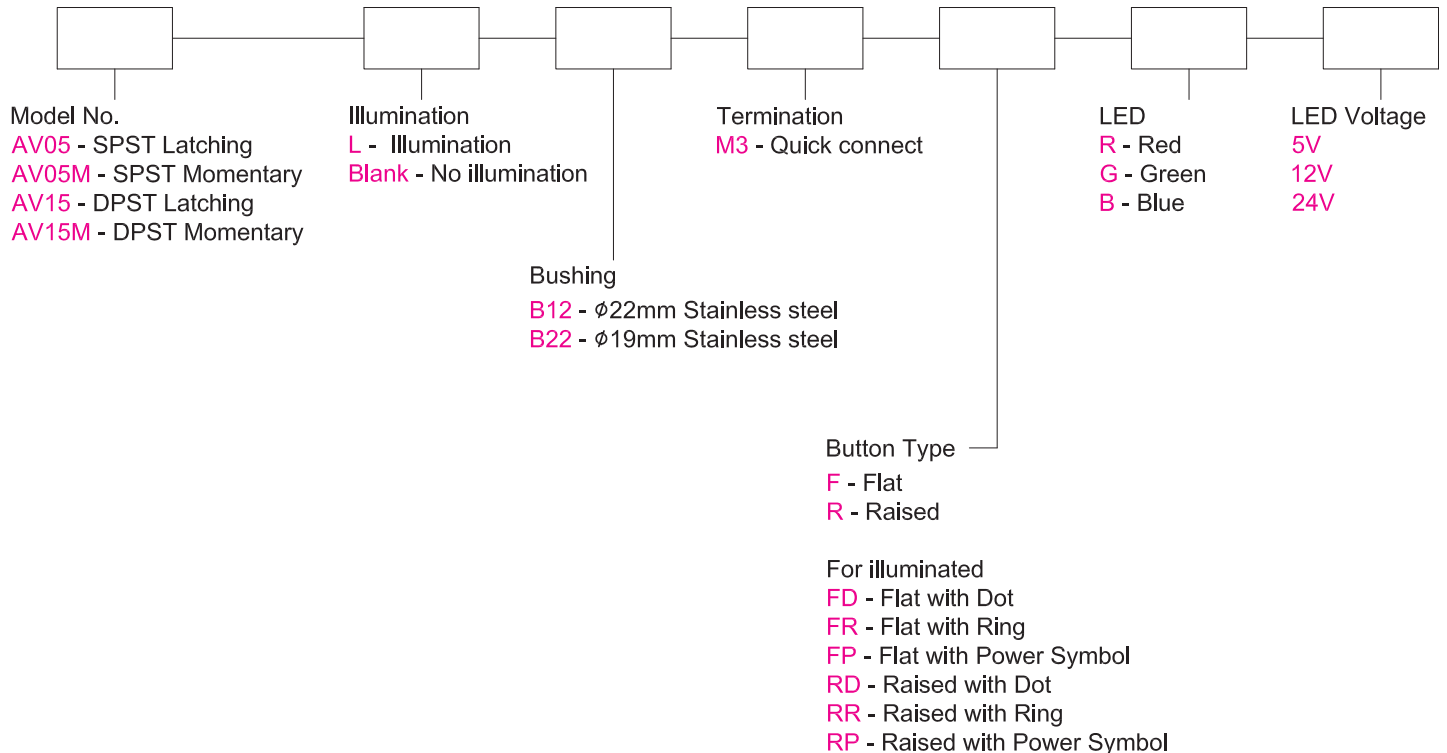

Series AVX5

Anti-Vandal Pushbutton Switches

Non-latching & Latching $\varnothing 19\text{mm}$, Quick Connect

Model No.	SPST Switching Position	
AV05	OFF	ON
AV05M	OFF	MOM
Term. Comm.	OPEN	2-1

Model No.	DPST Switching Position	
AV15	OFF	ON
AV15M	OFF	MOM
Term. Comm.	OPEN	2-1, 4-3

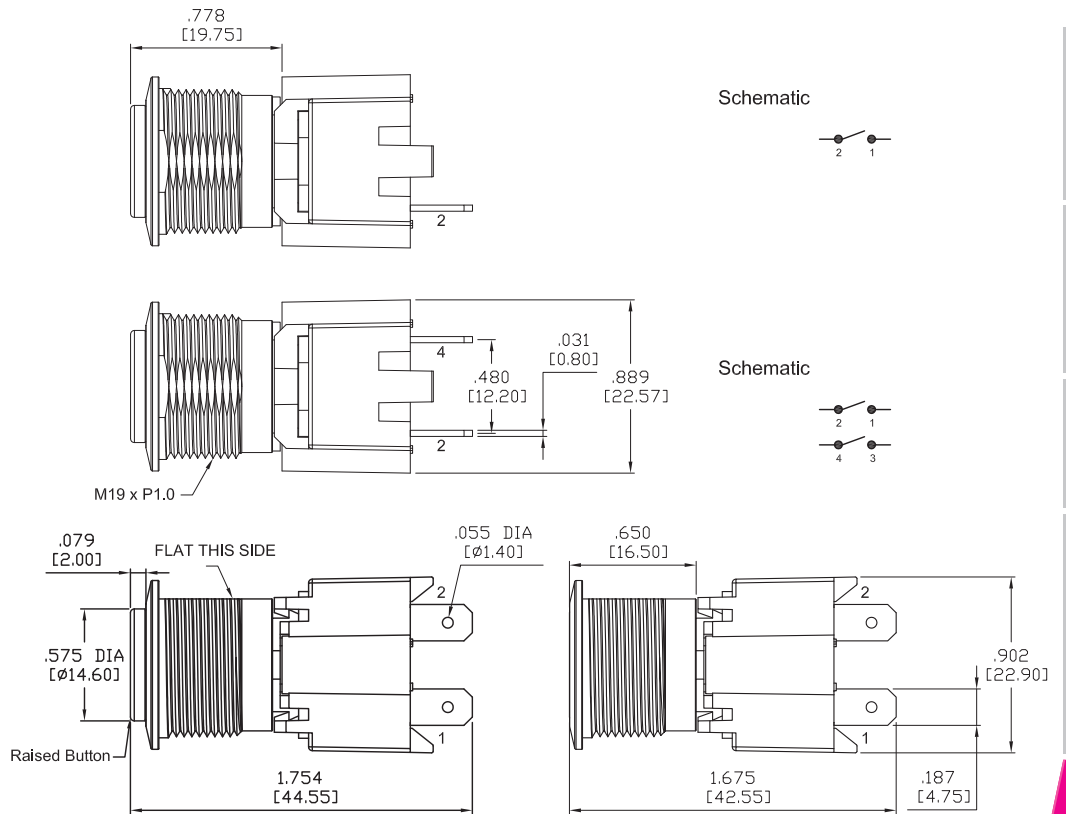
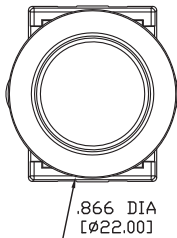

Toggle
Rocker
Slide
Pushbutton
AV

Non-latching & Latching $\varnothing 22\text{mm}$, Quick Connect

Model No.	SPST Switching Position	
AV05	OFF	ON
AV05M	OFF	MOM
Term. Comm.	OPEN	2-1

Model No.	DPST Switching Position	
AV15	OFF	ON
AV15M	OFF	MOM
Term. Comm.	OPEN	2-1, 4-3

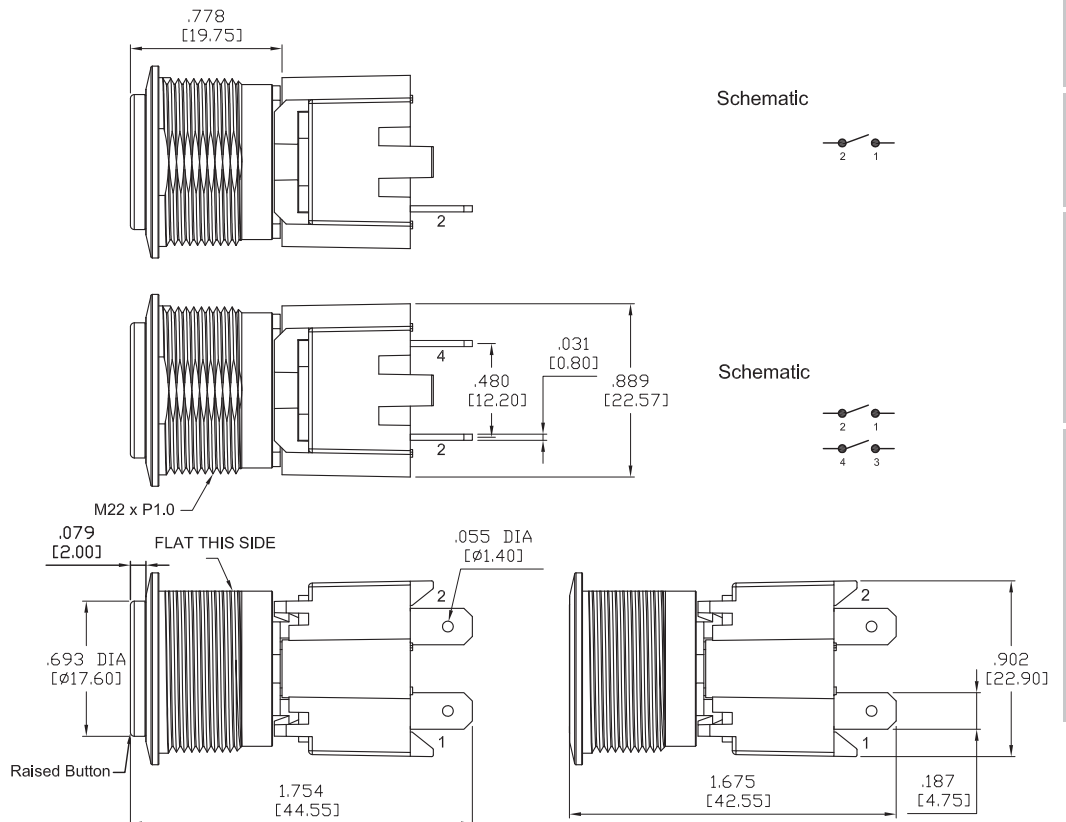
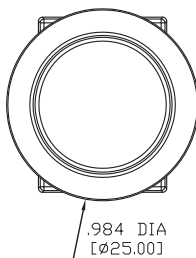

Rotary
Tact
Touch Key
Miscellaneous

Series AVX5

Anti-Vandal Pushbutton Switches

Illuminated Non-latching & Latching $\varnothing 19\text{mm}$, Quick Connect

Model No.	SPST Switching Position	
AV05	OFF	ON
AV05M	OFF	MOM
Term. Comm.	OPEN	2-1

Model No.	DPST Switching Position	
AV15	OFF	ON
AV15M	OFF	MOM
Term. Comm.	OPEN	2-1, 4-3

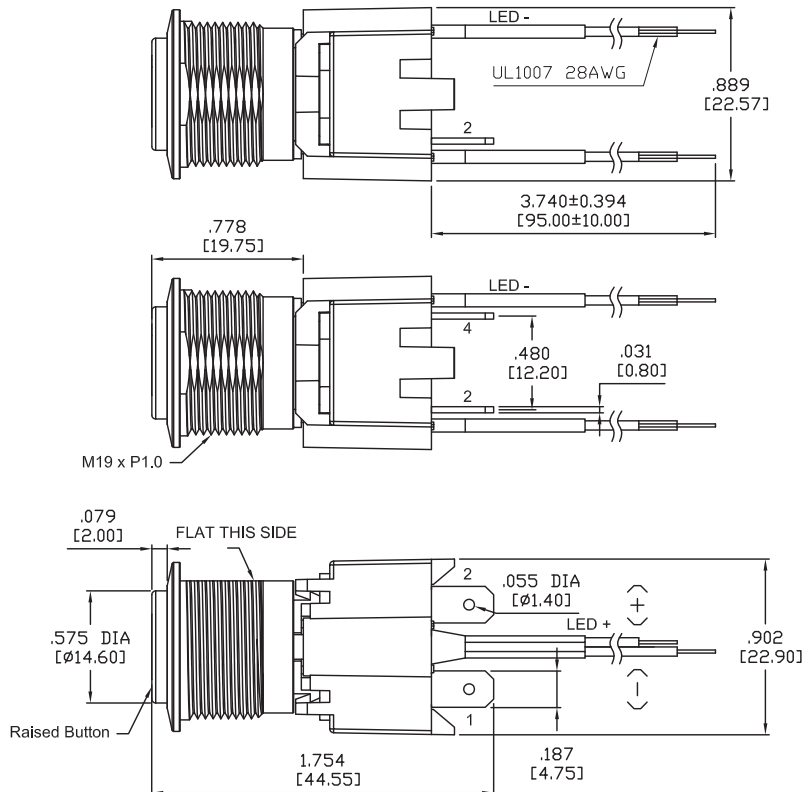
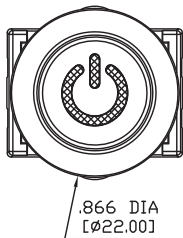

Schematic

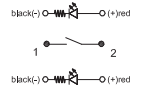

Schematic

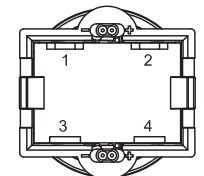
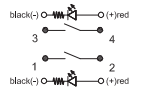

Illuminated Non-latching & Latching $\varnothing 22\text{mm}$, Quick Connect

Model No.	SPST Switching Position	
AV05	OFF	ON
AV05M	OFF	MOM
Term. Comm.	OPEN	2-1

Model No.	DPST Switching Position	
AV15	OFF	ON
AV15M	OFF	MOM
Term. Comm.	OPEN	2-1, 4-3

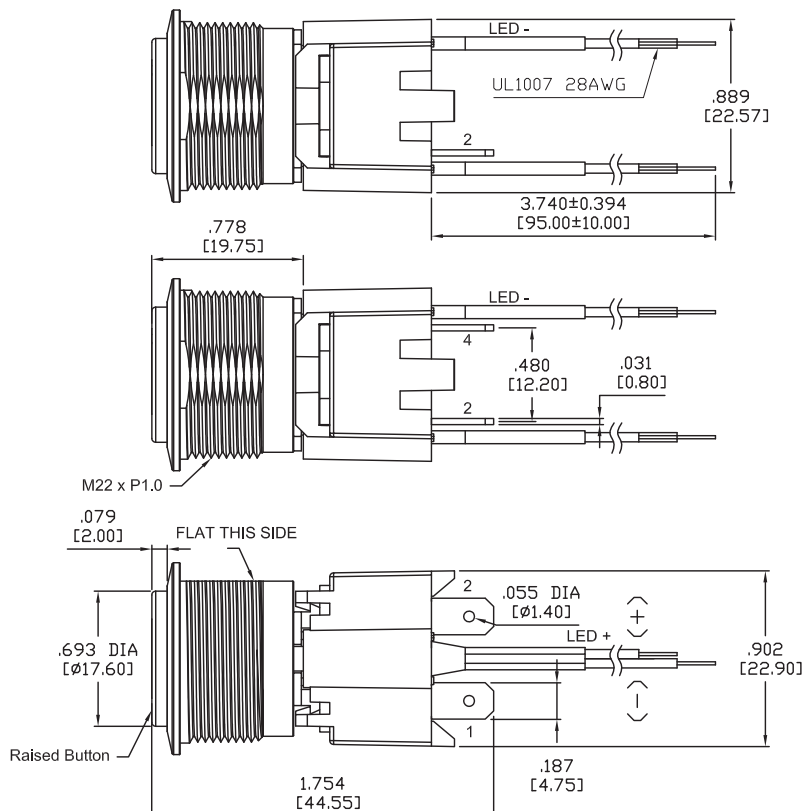
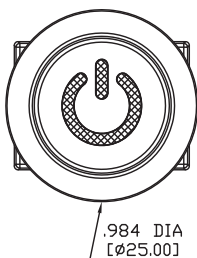

Schematic

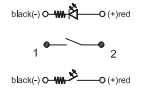

Schematic

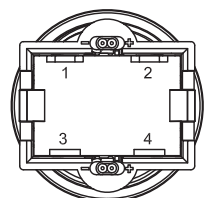
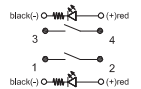

BUTTON TYPE

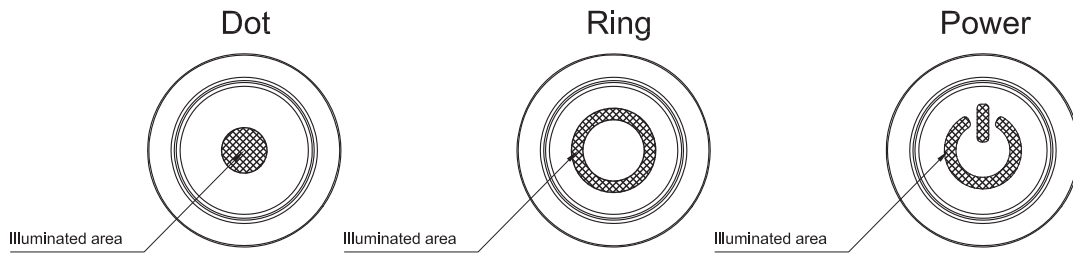

PANEL MOUNTING

M19 x 1.0 FLAT-CUT THD. BUSHING

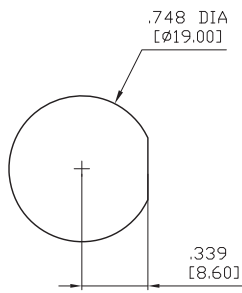

M22 x 1.0 FLAT-CUT THD. BUSHING

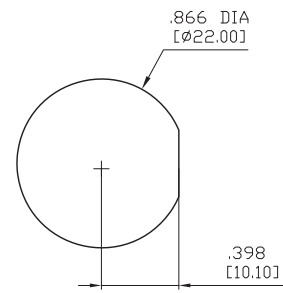

HARDWARE

M19 bushing

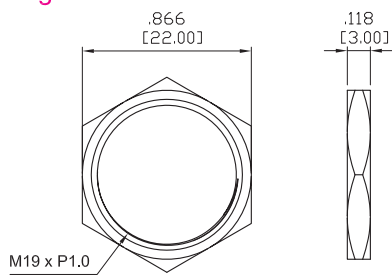

NUT

M22 bushing

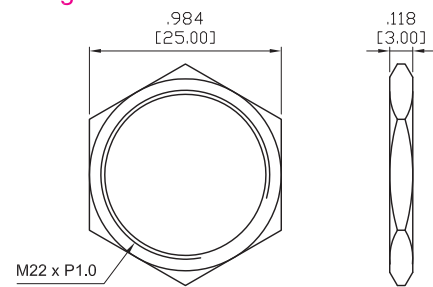

O-RING

M19 bushing

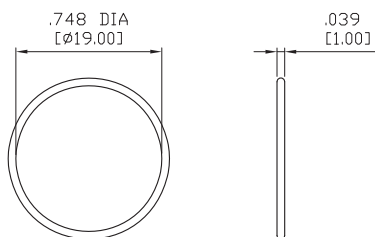

M22 bushing

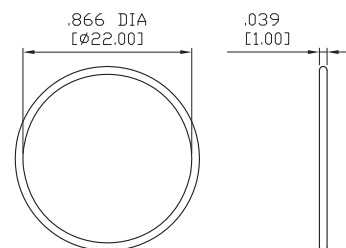

Toggle
Rocker
Slide
Pushbutton
AV
Rotary
Tact
Touch Key
Miscellaneous