

DS-XX-1717-1

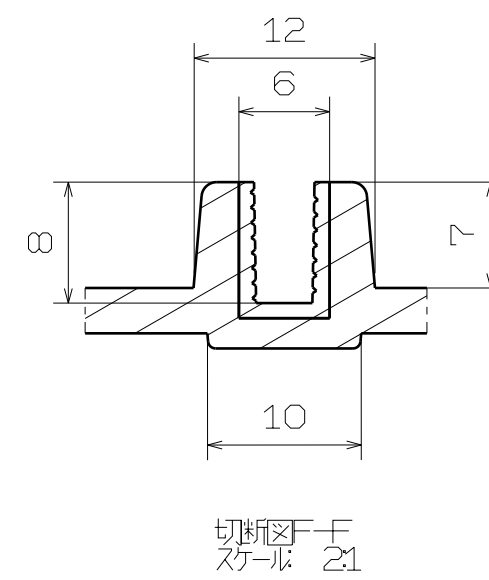

COVER BOLT

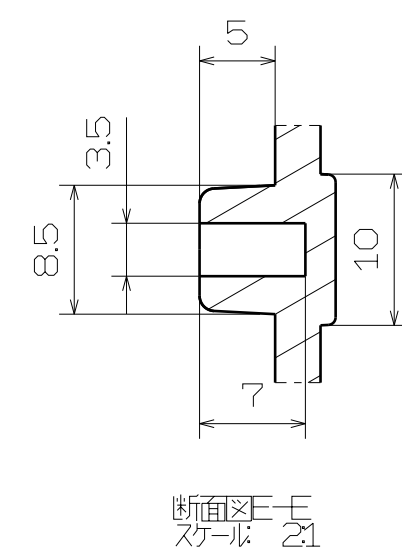
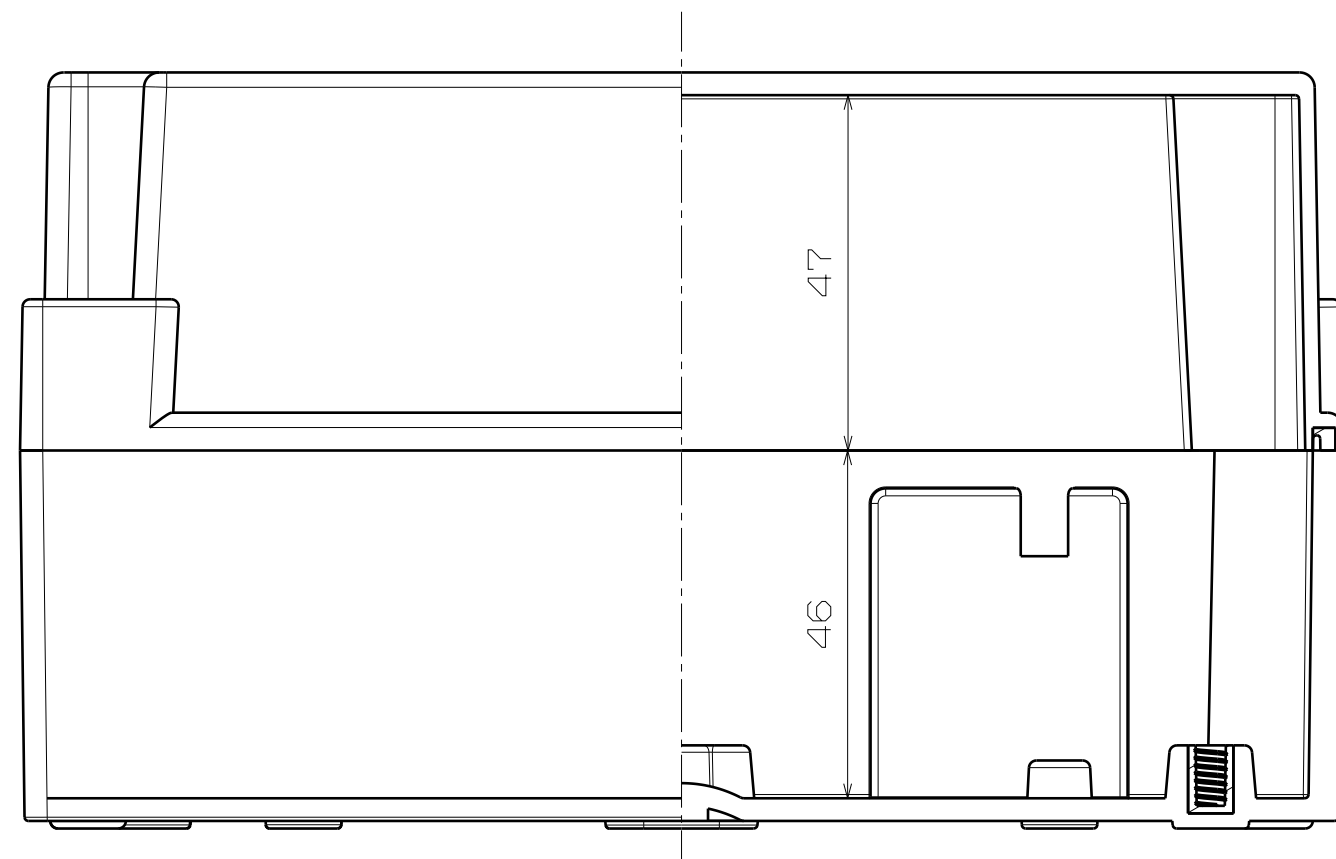
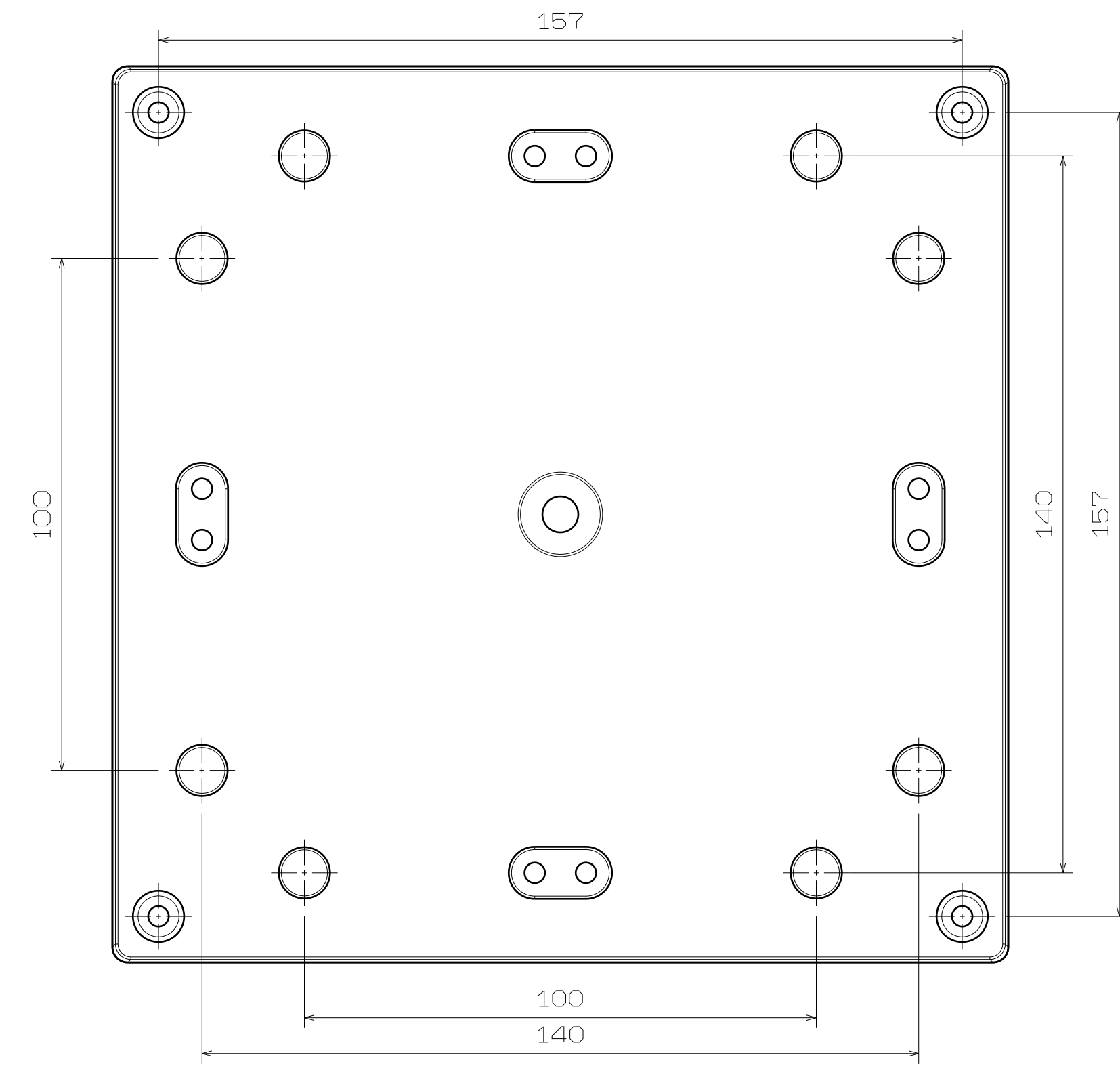
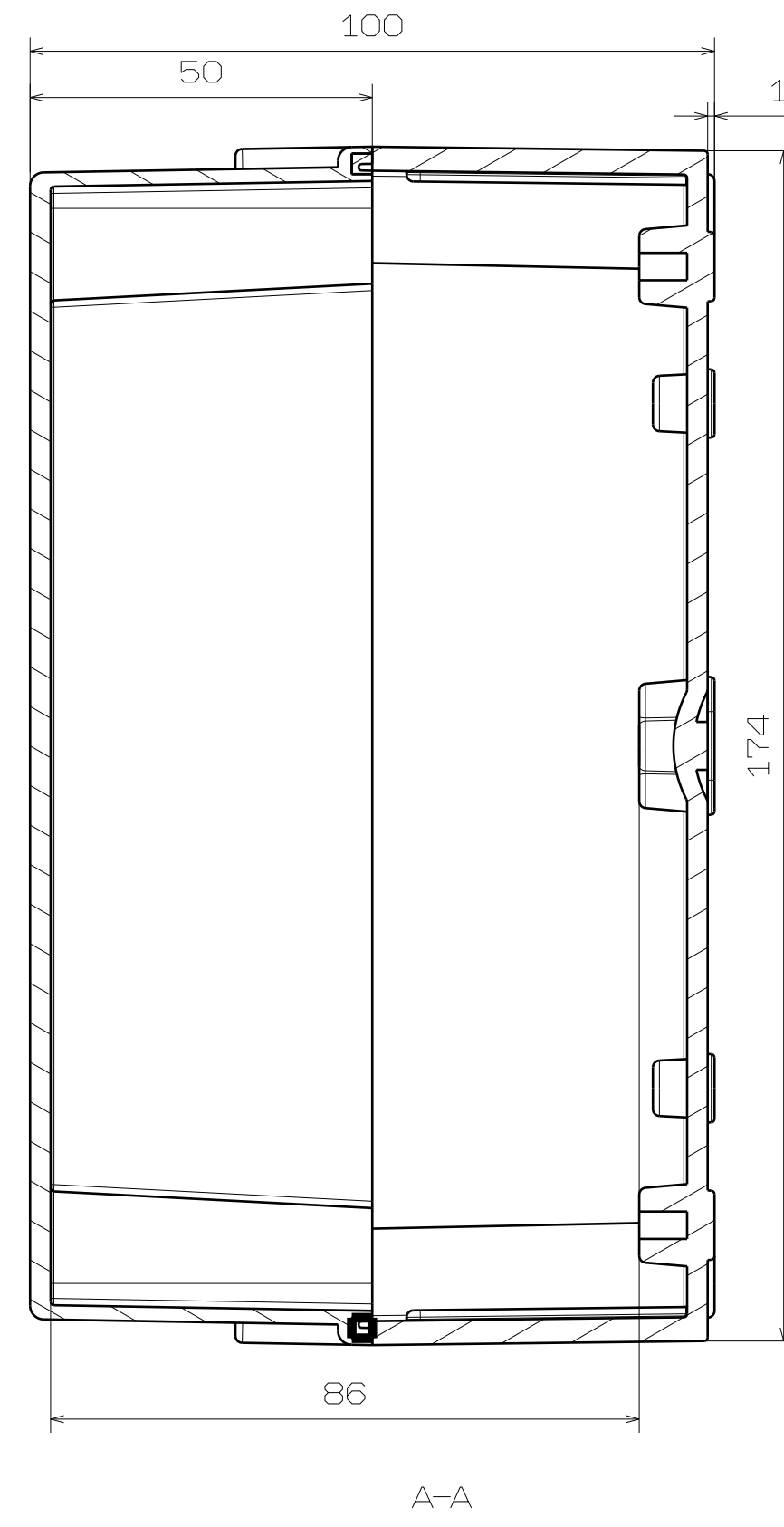
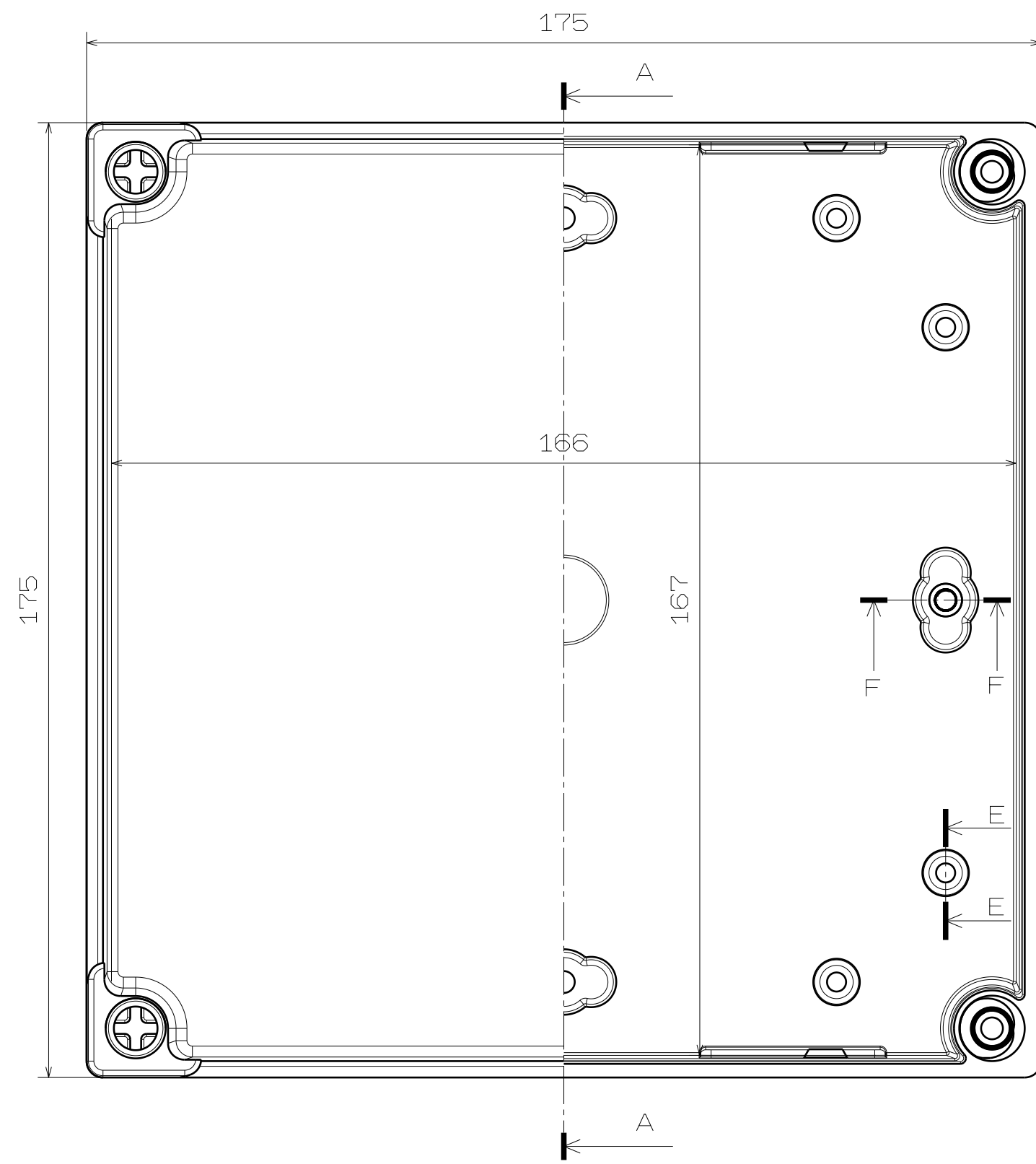
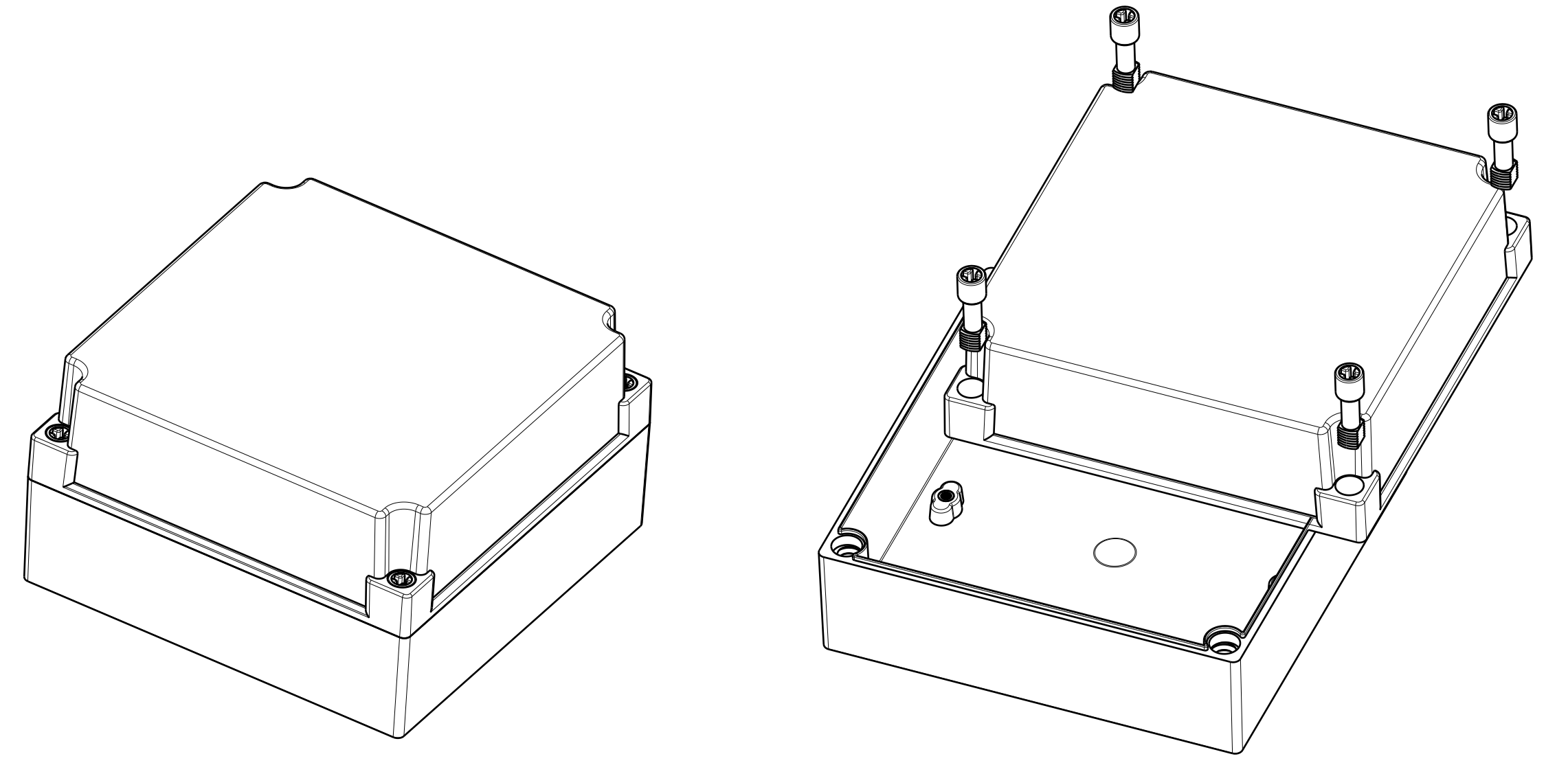