

<BODY>

<COVER>

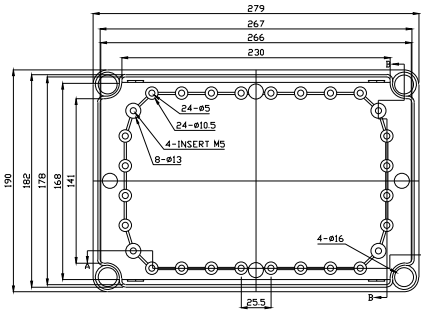

BODY-TOP

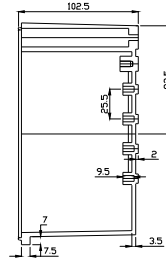

SECTION B-B

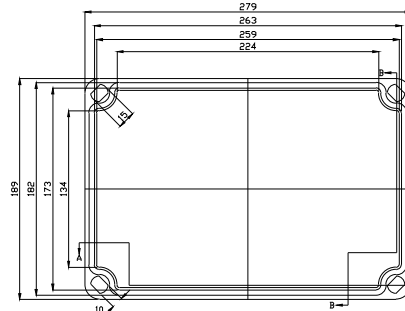

COVER-BOTTOM

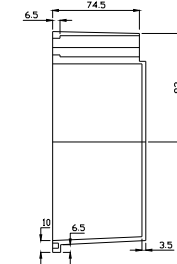

SECTION B-B

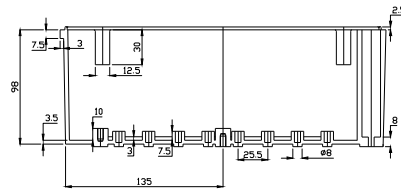

SECTION A-A

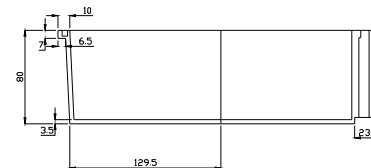

SECTION A-A

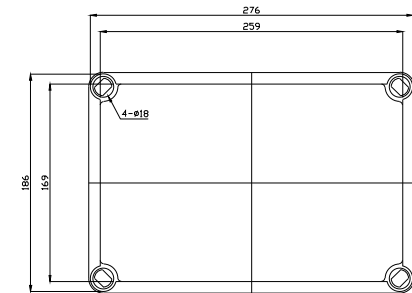

COVER-TOP

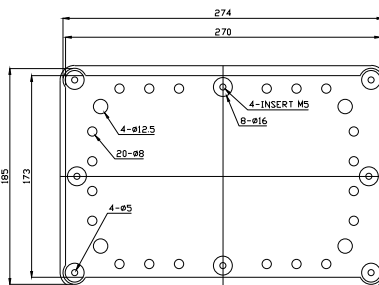

BODY-BOTTOM

NOTES:

- 1. A box includes 4 pcs of bolts.
- 2. Boxes designed to meet these standards:
 TUV - IP 67 for all material
 UL - Type 4X for PG/PT, PCG/PCT
 ROHS & REACH compliant

Tolerance:

All dimensions have ± 1mm

The information contained in this drawing is the sole property of DSE, Inc. Any reproduction in part or whole without the written permission of DSE, Inc. is prohibited.
 DSE, INC.

PART NO.	MATERIAL		USE
	BODY	COVER	
DS-AG-2819-1	ABS	ABS	INDOOR
DS-AT-2819-1	ABS	CLEAR PC	INDOOR
DS-PG-2819-1	ABS / PC	ABS / PC	INDOOR
DS-PT-2819-1	ABS / PC	CLEAR PC	INDOOR
DS-PCG-2819-1	PBT / PC	PBT / PC	OUTDOOR
DS-PCT-2819-1	PBT / PC	CLEAR PC	OUTDOOR