

28661.4 KDS-FP 3x10/24 BK



Cable entry flange plate with foamed-in frame gasket, Mounting type: Screw, Length: 165 mm, Width: 174 mm, IP66, Colour: Black

RAL: 9005

Business data

Article number	28661.4
Article name	KDS-FP 3x10/24 BK
GTIN (EAN)	4044211220365
Packaging unit	1
Quantity unit	PC
Weight per piece (not including packaging)	153 g
Weight per piece (including packaging)	160 g
Unit of weight	G
Customs number	39259020
Country of origin	DE
Product description	Cable Entry
Colour	Black

Technical data

Dimensions

Length	165 mm
Width	174 mm
Height	17.5 mm
Installation height	10.5 mm
Diameter of the screw holes	5.5 mm

Materials

Material	Polyamide 6.6
Glass-fibre reinforced	✓
Flammability class UL 94	V-0
Working temperature, min.	-40 °C
Working temperature, max.	120 °C
Sealing material	Polyurethane-based
Type of seal	Sealing and moulded flexible foam
Halogen-free	✓
Silicone-free	✓

Further technical data

Mounting type	Screws
Degree of protection	IP66
NEMA Type	1, 12, 4x (indoor use only)
Number of screw holes	8
Fixing screws	M 5 (ISO 4762 / DIN 912)
Torque of the fixing screws	3 Nm

Environmental Product Compliance

REACH Conform	yes
REACH Reference date	2023-01-17
REACH Candidate Substance Note	No
RoHS Conform	yes

28661.4 KDS-FP 3x10/24 BK

Approvals

cUL Recognized

cUL approval	C22.2 No. 14-18
cUL File Number	E489821
cUL Recognized	1

UL Recognized

UL approval	UL 508A
UL File Number	E489821
UL Recognized	1
UL Type Rating	1, 12, 4x (indoor use only)

Media

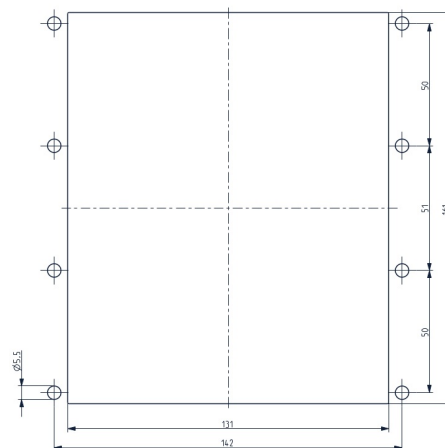
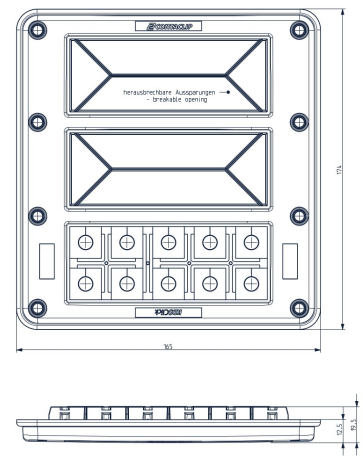
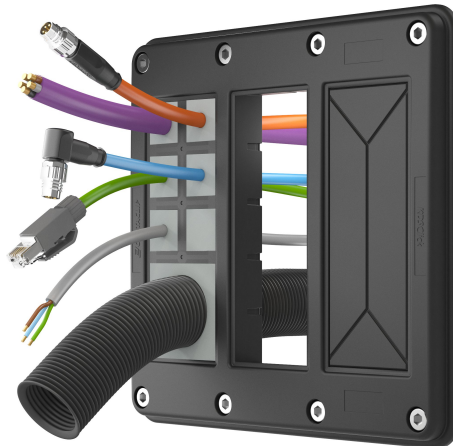

Accessories

Small Seals



Seal, Mounting type: Plug in, Length x width: 20.3 mm, Max. cable diameter: 7 mm, IP 66, Colour: Grey

Article number	Article name	GTIN (EAN)	Packaging unit
<u>28567.6</u>	KDS-DE 6-7 GR	4044211211059	10 ST



Seal, Mounting type: Plug in, Length x width: 20.3 mm, Max. cable diameter: 8 mm, IP 66, Colour: Grey

Article number	Article name	GTIN (EAN)	Packaging unit
<u>28568.6</u>	KDS-DE 7-8 GR	4044211211066	10 ST



Seal, Mounting type: Plug in, Length x width: 20.3 mm, Max. cable diameter: 9 mm, IP 66, Colour: Grey

Article number	Article name	GTIN (EAN)	Packaging unit
<u>28569.6</u>	KDS-DE 8-9 GR	4044211211073	10 ST



Seal, Mounting type: Plug in, Length x width: 20.3 mm, Max. cable diameter: 10 mm, IP 66, Colour: Grey

Article number	Article name	GTIN (EAN)	Packaging unit
<u>28570.6</u>	KDS-DE 9-10 GR	4044211211080	10 ST



Seal, Mounting type: Plug in, Length x width: 20.3 mm, Max. cable diameter: 11 mm, IP 66, Colour: Grey

Article number	Article name	GTIN (EAN)	Packaging unit
<u>28571.6</u>	KDS-DE 10-11 GR	4044211211097	10 ST



Seal, Mounting type: Plug in, Length x width: 20.3 mm, Max. cable diameter: 12 mm, IP 66, Colour: Grey

Article number	Article name	GTIN (EAN)	Packaging unit
<u>28572.6</u>	KDS-DE 11-12 GR	4044211211103	10 ST

28661.4 KDS-FP 3x10/24 BK

Small Seals



Seal, Mounting type: Plug in, Length x width: 20.3 mm, Max. cable diameter: 13 mm, IP 66, Colour: Grey

Article number	Article name	GTIN (EAN)	Packaging unit
28573.6	KDS-DE 12-13 GR	4044211215224	10 ST



Seal, Mounting type: Plug in, Length x width: 20.3 mm, Max. cable diameter: 3 mm, IP 66, Colour: Grey

Article number	Article name	GTIN (EAN)	Packaging unit
28563.6	KDS-DE 2-3 GR	4044211211011	10 ST



Seal, Mounting type: Plug in, Length x width: 20.3 mm, Max. cable diameter: 4 mm, IP 66, Colour: Grey

Article number	Article name	GTIN (EAN)	Packaging unit
28564.6	KDS-DE 3-4 GR	4044211211028	10 ST



Seal, Mounting type: Plug in, Length x width: 20.3 mm, Max. cable diameter: 5 mm, IP 66, Colour: Grey

Article number	Article name	GTIN (EAN)	Packaging unit
28565.6	KDS-DE 4-5 GR	4044211211035	10 ST



Seal, Mounting type: Plug in, Length x width: 20.3 mm, Max. cable diameter: 6 mm, IP 66, Colour: Grey

Article number	Article name	GTIN (EAN)	Packaging unit
28566.6	KDS-DE 5-6 GR	4044211211042	10 ST



Seal, Mounting type: Plug in, Length x width: 20.3 mm, Max. cable diameter: 14 mm, IP 66, Colour: Grey

Article number	Article name	GTIN (EAN)	Packaging unit
28574.6	KDS-DE 13-14 GR	4044211215231	10 ST



Seal, Mounting type: Plug in, Length x width: 20.3 mm, Max. cable diameter: 5 mm, IP 66, Colour: Grey

Article number	Article name	GTIN (EAN)	Packaging unit
28595.6	KDS-DE 2X4-5 GR	4044211215682	10 ST

28661.4 KDS-FP 3x10/24 BK

Small Seals



Seal, Mounting type: Plug in, Length x width: 20.3 mm, Max. cable diameter: 6 mm, IP 66, Colour: Grey

Article number	Article name	GTIN (EAN)	Packaging unit
<u>28596.6</u>	KDS-DE 2X5-6 GR	4044211215699	10 ST



Seal, Mounting type: Plug in, Length x width: 20.3 mm, Max. cable diameter: 3 mm, IP 66, Colour: Grey

Article number	Article name	GTIN (EAN)	Packaging unit
<u>28597.6</u>	KDS-DE 4X2-3 GR	4044211215705	10 ST



Seal, Mounting type: Plug in, Length x width: 20.3 mm, Max. cable diameter: 4 mm, IP 66, Colour: Grey

Article number	Article name	GTIN (EAN)	Packaging unit
<u>28598.6</u>	KDS-DE 4X3-4 GR	4044211215712	10 ST



Seal, Mounting type: Plug in, Length x width: 20.3 mm, IP 66, Colour: Black

Article number	Article name	GTIN (EAN)	Packaging unit
<u>28560.4</u>	KDS-DE/2XASI BK	4044211215675	10 ST



Seal dummy, Mounting type: Plug in, Length x width: 20.3 mm, IP 66, Colour: Grey

Article number	Article name	GTIN (EAN)	Packaging unit
<u>28561.6</u>	KDS-DE/B GR	4044211211004	10 ST



Seal, Mounting type: Plug in, Length x width: 20.3 mm, Max. cable diameter: 2 mm, IP 66, Colour: Grey

Article number	Article name	GTIN (EAN)	Packaging unit
<u>28562.6</u>	KDS-DE 1,5-2 GR	4044211209988	10 ST



Seal, Mounting type: Plug in, Length x width: 20.3 mm, Max. cable diameter: 6.5 mm, IP 66, Colour: Black

Article number	Article name	GTIN (EAN)	Packaging unit
<u>28682.4</u>	KDS-DE 2X6,5 BK	4044211219536	10 ST

28661.4 KDS-FP 3x10/24 BK

Small Seals



Seal, Mounting type: Plug in, Length x width: 20.3 mm, Max. cable diameter: 6.5 mm, IP 66, Colour: Black

Article number	Article name	GTIN (EAN)	Packaging unit
<u>28687.4</u>	KDS-DE 3X5-6 BK	4044211220501	10 ST



Seal, Mounting type: Plug in, Length x width: 20.3 mm, Max. cable diameter: 2 mm, IP 66, Colour: Grey

Article number	Article name	GTIN (EAN)	Packaging unit
<u>28696.6</u>	KDS-DE 2 GR	4044211220884	10 ST



Seal, Mounting type: Plug in, Length x width: 20.3 mm, Max. cable diameter: 3 mm, IP 66, Colour: Black

Article number	Article name	GTIN (EAN)	Packaging unit
<u>28697.4</u>	KDS-DE 3 BK	4044211220891	10 ST



Seal, Mounting type: Plug in, Length x width: 20.3 mm, Max. cable diameter: 3 mm, IP 66, Colour: Grey

Article number	Article name	GTIN (EAN)	Packaging unit
<u>28698.6</u>	KDS-DE 3 GR	4044211220907	10 ST



Seal, Mounting type: Plug in, Length x width: 20.3 mm, Max. cable diameter: 6.1 mm, IP 66, Colour: Grey

Article number	Article name	GTIN (EAN)	Packaging unit
<u>28762.6</u>	KDS-DE 4X6 GR	4044211226459	10 ST



Seal, Mounting type: Plug in, Length x width: 20.3 mm, Max. cable diameter: 6.1 mm, IP 66, Colour: Black

Article number	Article name	GTIN (EAN)	Packaging unit
<u>28763.4</u>	KDS-DE 4X6 BK	4044211226466	10 ST



Seal, Mounting type: Plug in, Length x width: 20.3 mm, IP 66, Colour: Grey

Article number	Article name	GTIN (EAN)	Packaging unit
<u>28600.6</u>	KDS-DE/2XASI GR	4044211215736	10 ST

28661.4 KDS-FP 3x10/24 BK

Small Seals



Seal, Mounting type: Plug in, Length x width: 20.3 mm, Max. cable diameter: 4.5 mm, IP 66, Colour: Grey

Article number	Article name	GTIN (EAN)	Packaging unit
<u>28606.6</u>	KDS-DE 4X4,5 GR	4044211216252	10 ST



Seal, Mounting type: Plug in, Length x width: 20.3 mm, Max. cable diameter: 6.5 mm, IP 66, Colour: Grey

Article number	Article name	GTIN (EAN)	Packaging unit
<u>28607.6</u>	KDS-DE 2X6,5 GR	4044211216238	10 ST



Seal, Mounting type: Plug in, Length x width: 20.3 mm, Max. cable diameter: 15 mm, IP 66, Colour: Black

Article number	Article name	GTIN (EAN)	Packaging unit
<u>28608.4</u>	KDS-DE 14-15 BK	4044211219314	10 ST



Seal, Mounting type: Plug in, Length x width: 20.3 mm, Max. cable diameter: 15 mm, IP 66, Colour: Grey

Article number	Article name	GTIN (EAN)	Packaging unit
<u>28609.6</u>	KDS-DE 14-15 GR	4044211219307	10 ST



Seal, Mounting type: Plug in, Length x width: 20.3 mm, Max. cable diameter: 16 mm, IP 66, Colour: Black

Article number	Article name	GTIN (EAN)	Packaging unit
<u>28670.4</u>	KDS-DE 15-16 BK	4044211219321	10 ST



Seal, Mounting type: Plug in, Length x width: 20.3 mm, Max. cable diameter: 17 mm, IP 66, Colour: Grey

Article number	Article name	GTIN (EAN)	Packaging unit
<u>28671.6</u>	KDS-DE 15-16 GR	4044211219338	10 ST



Seal, Mounting type: Plug in, Length x width: 20.3 mm, Max. cable diameter: 5 mm, IP 66, Colour: Black

Article number	Article name	GTIN (EAN)	Packaging unit
<u>28672.4</u>	KDS-DE 4X5 BK	4044211219345	10 ST

28661.4 KDS-FP 3x10/24 BK

Small Seals



Seal, Mounting type: Plug in, Length x width: 20.3 mm, Max. cable diameter: 5 mm, IP 66, Colour: Grey

Article number	Article name	GTIN (EAN)	Packaging unit
<u>28673.6</u>	KDS-DE 4X5 GR	4044211219352	10 ST



Seal, Mounting type: Plug in, Length x width: 20.3 mm, Max. cable diameter: 4.5 mm, IP 66, Colour: Black

Article number	Article name	GTIN (EAN)	Packaging unit
<u>28681.4</u>	KDS-DE 4X4,5 BK	4044211219543	10 ST



Seal, Mounting type: Plug in, Length x width: 20.3 mm, Max. cable diameter: 11 mm, IP 66, Colour: Black

Article number	Article name	GTIN (EAN)	Packaging unit
<u>28530.4</u>	KDS-DE 10-11 BK	4044211210960	10 ST



Seal, Mounting type: Plug in, Length x width: 20.3 mm, Max. cable diameter: 12 mm, IP 66, Colour: Black

Article number	Article name	GTIN (EAN)	Packaging unit
<u>28531.4</u>	KDS-DE 11-12 BK	4044211210977	10 ST



Seal, Mounting type: Plug in, Length x width: 20.3 mm, Max. cable diameter: 13 mm, IP 66, Colour: Black

Article number	Article name	GTIN (EAN)	Packaging unit
<u>28532.4</u>	KDS-DE 12-13 BK	4044211210984	10 ST



Seal, Mounting type: Plug in, Length x width: 20.3 mm, Max. cable diameter: 14 mm, IP 66, Colour: Black

Article number	Article name	GTIN (EAN)	Packaging unit
<u>28533.4</u>	KDS-DE 13-14 BK	4044211210991	10 ST



Seal, Mounting type: Plug in, Length x width: 20.3 mm, Max. cable diameter: 11 mm, IP 66, Colour: Black

Article number	Article name	GTIN (EAN)	Packaging unit
<u>28553.4</u>	KDS-DE/K 2-11 BK	4044211216092	10 ST

28661.4 KDS-FP 3x10/24 BK

Small Seals



Seal, Mounting type: Plug in, Length x width: 20.3 mm, Max. cable diameter: 5 mm, IP 66, Colour: Black

Article number	Article name	GTIN (EAN)	Packaging unit
28555.4	KDS-DE 2X4-5 BK	4044211215620	10 ST



Seal, Mounting type: Plug in, Length x width: 20.3 mm, Max. cable diameter: 6 mm, IP 66, Colour: Black

Article number	Article name	GTIN (EAN)	Packaging unit
28556.4	KDS-DE 2X5-6 BK	4044211215637	10 ST



Seal, Mounting type: Plug in, Length x width: 20.3 mm, Max. cable diameter: 3 mm, IP 66, Colour: Black

Article number	Article name	GTIN (EAN)	Packaging unit
28557.4	KDS-DE 4X2-3 BK	4044211215644	10 ST



Seal, Mounting type: Plug in, Length x width: 20.3 mm, Max. cable diameter: 4 mm, IP 66, Colour: Black

Article number	Article name	GTIN (EAN)	Packaging unit
28558.4	KDS-DE 4X3-4 BK	4044211215651	10 ST



Seal, Mounting type: Plug in, Length x width: 20.3 mm, IP 66, Colour: Black

Article number	Article name	GTIN (EAN)	Packaging unit
28559.4	KDS-DE/1XASI BK	4044211215668	10 ST



Seal dummy, Mounting type: Plug in, Length x width: 20.3 mm, IP 66, Colour: Black

Article number	Article name	GTIN (EAN)	Packaging unit
28520.4	KDS-DE/B BK	4044211210878	10 ST



Seal, Mounting type: Plug in, Length x width: 20.3 mm, Max. cable diameter: 2 mm, IP 66, Colour: Black

Article number	Article name	GTIN (EAN)	Packaging unit
28521.4	KDS-DE 1,5-2 BK	4044211210007	10 ST

28661.4 KDS-FP 3x10/24 BK

Small Seals



Seal, Mounting type: Plug in, Length x width: 20.3 mm, Max. cable diameter: 3 mm, IP 66, Colour: Black

Article number	Article name	GTIN (EAN)	Packaging unit
<u>28522.4</u>	KDS-DE 2-3 BK	4044211210885	10 ST



Seal, Mounting type: Plug in, Length x width: 20.3 mm, Max. cable diameter: 4 mm, IP 66, Colour: Black

Article number	Article name	GTIN (EAN)	Packaging unit
<u>28523.4</u>	KDS-DE 3-4 BK	4044211210892	10 ST



Seal, Mounting type: Plug in, Length x width: 20.3 mm, Max. cable diameter: 5 mm, IP 66, Colour: Black

Article number	Article name	GTIN (EAN)	Packaging unit
<u>28524.4</u>	KDS-DE 4-5 BK	4044211210908	10 ST



Seal, Mounting type: Plug in, Length x width: 20.3 mm, Max. cable diameter: 6 mm, IP 66, Colour: Black

Article number	Article name	GTIN (EAN)	Packaging unit
<u>28525.4</u>	KDS-DE 5-6 BK	4044211210915	10 ST



Seal, Mounting type: Plug in, Length x width: 20.3 mm, Max. cable diameter: 7 mm, IP 66, Colour: Black

Article number	Article name	GTIN (EAN)	Packaging unit
<u>28526.4</u>	KDS-DE 6-7 BK	4044211210922	10 ST



Seal, Mounting type: Plug in, Length x width: 20.3 mm, Max. cable diameter: 8 mm, IP 66, Colour: Black

Article number	Article name	GTIN (EAN)	Packaging unit
<u>28527.4</u>	KDS-DE 7-8 BK	4044211210939	10 ST



Seal, Mounting type: Plug in, Length x width: 20.3 mm, Max. cable diameter: 9 mm, IP 66, Colour: Black

Article number	Article name	GTIN (EAN)	Packaging unit
<u>28528.4</u>	KDS-DE 8-9 BK	4044211210946	10 ST

28661.4 KDS-FP 3x10/24 BK

Small Seals



Seal, Mounting type: Plug in, Length x width: 20.3 mm, Max. cable diameter: 10 mm, IP 66, Colour: Black

Article number	Article name	GTIN (EAN)	Packaging unit
<u>28529.4</u>	KDS-DE 9-10 BK	4044211210953	10 ST



Seal, Mounting type: Plug in, Length x width: 20.3 mm, Max. cable diameter: 6 mm, IP 66, Colour: Grey

Article number	Article name	GTIN (EAN)	Packaging unit
<u>28688.6</u>	KDS-DE 3X5-6 GR	4044211220518	10 ST



Seal, Mounting type: Plug in, Length x width: 20.3 mm, Max. cable diameter: 7 mm, IP 66, Colour: Black

Article number	Article name	GTIN (EAN)	Packaging unit
<u>28689.4</u>	KDS-DE 2X7 BK	4044211220815	10 ST



Seal, Mounting type: Plug in, Length x width: 20.3 mm, Max. cable diameter: 7 mm, IP 66, Colour: Grey

Article number	Article name	GTIN (EAN)	Packaging unit
<u>28690.6</u>	KDS-DE 2X7 GR	4044211220822	10 ST



Seal, Mounting type: Plug in, Length x width: 20.3 mm, Max. cable diameter: 8 mm, IP 66, Colour: Black

Article number	Article name	GTIN (EAN)	Packaging unit
<u>28691.4</u>	KDS-DE 2X8 BK	4044211220839	10 ST



Seal, Mounting type: Plug in, Length x width: 20.3 mm, Max. cable diameter: 8 mm, IP 66, Colour: Grey

Article number	Article name	GTIN (EAN)	Packaging unit
<u>28692.6</u>	KDS-DE 2X8 GR	4044211220846	10 ST



Seal, Mounting type: Plug in, Length x width: 20.3 mm, Max. cable diameter: 1.5 mm, IP 66, Colour: Black

Article number	Article name	GTIN (EAN)	Packaging unit
<u>28693.4</u>	KDS-DE 1,5 BK	4044211220853	10 ST

28661.4 KDS-FP 3x10/24 BK

Small Seals



Seal, Mounting type: Plug in, Length x width: 20.3 mm, Max. cable diameter: 1.5 mm, IP 66, Colour: Grey

Article number	Article name	GTIN (EAN)	Packaging unit
<u>28694.6</u>	KDS-DE 1,5 GR	4044211220860	10 ST



Seal, Mounting type: Plug in, Length x width: 20.3 mm, Max. cable diameter: 2 mm, IP 66, Colour: Black

Article number	Article name	GTIN (EAN)	Packaging unit
<u>28695.4</u>	KDS-DE 2 BK	4044211220877	10 ST

Big Seals



Seal, Mounting type: Plug in, Length x width: 42.8 mm, Max. cable diameter: 20 mm, IP 66, Colour: Black

Article number	Article name	GTIN (EAN)	Packaging unit
<u>28540.4</u>	KDS-DEG 19-20 BK	4044211215354	10 ST



Seal, Mounting type: Plug in, Length x width: 42.8 mm, Max. cable diameter: 33 mm, IP 66, Colour: Black

Article number	Article name	GTIN (EAN)	Packaging unit
<u>28601.4</u>	KDS-DEG 32-33 BK	4044211215613	10 ST



Seal dummy, Mounting type: Plug in, Length x width: 42.8 mm, IP 66, Colour: Black

Article number	Article name	GTIN (EAN)	Packaging unit
<u>28534.4</u>	KDS-DEG/B BK	4044211215255	10 ST



Seal, Mounting type: Plug in, Length x width: 42.8 mm, Max. cable diameter: 15 mm, IP 66, Colour: Black

Article number	Article name	GTIN (EAN)	Packaging unit
<u>28535.4</u>	KDS-DEG 14-15 BK	4044211209995	10 ST

28661.4 KDS-FP 3x10/24 BK

Big Seals



Seal, Mounting type: Plug in, Length x width: 42.8 mm, Max. cable diameter: 16 mm, IP 66, Colour: Black

Article number	Article name	GTIN (EAN)	Packaging unit
<u>28536.4</u>	KDS-DEG 15-16 BK	4044211215279	10 ST



Seal, Mounting type: Plug in, Length x width: 42.8 mm, Max. cable diameter: 17 mm, IP 66, Colour: Black

Article number	Article name	GTIN (EAN)	Packaging unit
<u>28537.4</u>	KDS-DEG 16-17 BK	4044211215293	10 ST



Seal, Mounting type: Plug in, Length x width: 42.8 mm, Max. cable diameter: 18 mm, IP 66, Colour: Black

Article number	Article name	GTIN (EAN)	Packaging unit
<u>28538.4</u>	KDS-DEG 17-18 BK	4044211215316	10 ST



Seal, Mounting type: Plug in, Length x width: 42.8 mm, Max. cable diameter: 24 mm, IP 66, Colour: Black

Article number	Article name	GTIN (EAN)	Packaging unit
<u>28544.4</u>	KDS-DEG 23-24 BK	4044211215439	10 ST



Seal, Mounting type: Plug in, Length x width: 42.8 mm, Max. cable diameter: 20 mm, IP 66, Colour: Grey

Article number	Article name	GTIN (EAN)	Packaging unit
<u>28581.6</u>	KDS-DEG 19-20 GR	4044211215347	10 ST



Seal, Mounting type: Plug in, Length x width: 42.8 mm, Max. cable diameter: 21 mm, IP 66, Colour: Grey

Article number	Article name	GTIN (EAN)	Packaging unit
<u>28582.6</u>	KDS-DEG 20-21 GR	4044211215361	10 ST



Seal, Mounting type: Plug in, Length x width: 42.8 mm, Max. cable diameter: 22 mm, IP 66, Colour: Grey

Article number	Article name	GTIN (EAN)	Packaging unit
<u>28583.6</u>	KDS-DEG 21-22 GR	4044211215385	10 ST

28661.4 KDS-FP 3x10/24 BK

Big Seals



Seal, Mounting type: Plug in, Length x width: 42.8 mm, Max. cable diameter: 23 mm, IP 66, Colour: Grey

Article number	Article name	GTIN (EAN)	Packaging unit
<u>28584.6</u>	KDS-DEG 22-23 GR	4044211215408	10 ST



Seal, Mounting type: Plug in, Length x width: 42.8 mm, Max. cable diameter: 25 mm, IP 66, Colour: Black

Article number	Article name	GTIN (EAN)	Packaging unit
<u>28545.4</u>	KDS-DEG 24-25 BK	4044211215453	10 ST



Seal, Mounting type: Plug in, Length x width: 42.8 mm, Max. cable diameter: 26 mm, IP 66, Colour: Black

Article number	Article name	GTIN (EAN)	Packaging unit
<u>28546.4</u>	KDS-DEG 25-26 BK	4044211215460	10 ST



Seal, Mounting type: Plug in, Length x width: 42.8 mm, Max. cable diameter: 27 mm, IP 66, Colour: Black

Article number	Article name	GTIN (EAN)	Packaging unit
<u>28547.4</u>	KDS-DEG 26-27 BK	4044211215491	10 ST



Seal, Mounting type: Plug in, Length x width: 42.8 mm, Max. cable diameter: 28 mm, IP 66, Colour: Black

Article number	Article name	GTIN (EAN)	Packaging unit
<u>28548.4</u>	KDS-DEG 27-28 BK	4044211215514	10 ST



Seal, Mounting type: Plug in, Length x width: 42.8 mm, Max. cable diameter: 29 mm, IP 66, Colour: Black

Article number	Article name	GTIN (EAN)	Packaging unit
<u>28549.4</u>	KDS-DEG 28-29 BK	4044211215538	10 ST

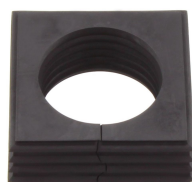

Seal, Mounting type: Plug in, Length x width: 42.8 mm, Max. cable diameter: 30 mm, IP 66, Colour: Black

Article number	Article name	GTIN (EAN)	Packaging unit
<u>28550.4</u>	KDS-DEG 29-30 BK	4044211215552	10 ST

28661.4 KDS-FP 3x10/24 BK

Big Seals

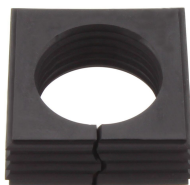

Seal, Mounting type: Plug in, Length x width: 42.8 mm, Max. cable diameter: 31 mm, IP 66, Colour: Black

Article number	Article name	GTIN (EAN)	Packaging unit
<u>28551.4</u>	KDS-DEG 30-31 BK	4044211215576	10 ST

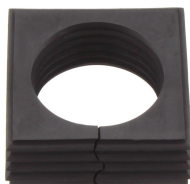

Seal, Mounting type: Plug in, Length x width: 42.8 mm, Max. cable diameter: 32 mm, IP 66, Colour: Black

Article number	Article name	GTIN (EAN)	Packaging unit
<u>28552.4</u>	KDS-DEG 31-32 BK	4044211215590	10 ST



Seal, Mounting type: Plug in, Length x width: 42.8 mm, Max. cable diameter: 18 mm, IP 66, Colour: Grey

Article number	Article name	GTIN (EAN)	Packaging unit
<u>28579.6</u>	KDS-DEG 17-18 GR	4044211215309	10 ST



Seal, Mounting type: Plug in, Length x width: 42.8 mm, Max. cable diameter: 19 mm, IP 66, Colour: Grey

Article number	Article name	GTIN (EAN)	Packaging unit
<u>28580.6</u>	KDS-DEG 18-19 GR	4044211215323	10 ST



Seal dummy, Mounting type: Plug in, Length x width: 42.8 mm, IP 66, Colour: Grey

Article number	Article name	GTIN (EAN)	Packaging unit
<u>28575.6</u>	KDS-DEG/B GR	4044211215248	10 ST



Seal, Mounting type: Plug in, Length x width: 42.8 mm, Max. cable diameter: 15 mm, IP 66, Colour: Grey

Article number	Article name	GTIN (EAN)	Packaging unit
<u>28576.6</u>	KDS-DEG 14-15 GR	4044211209971	10 ST



Seal, Mounting type: Plug in, Length x width: 42.8 mm, Max. cable diameter: 16 mm, IP 66, Colour: Grey

Article number	Article name	GTIN (EAN)	Packaging unit
<u>28577.6</u>	KDS-DEG 15-16 GR	4044211215262	10 ST

28661.4 KDS-FP 3x10/24 BK

Big Seals



Seal, Mounting type: Plug in, Length x width: 42.8 mm, Max. cable diameter: 17 mm, IP 66, Colour: Grey

Article number	Article name	GTIN (EAN)	Packaging unit
28578.6	KDS-DEG 16-17 GR	4044211215286	10 ST



Seal, Mounting type: Plug in, Length x width: 42.8 mm, Max. cable diameter: 32 mm, IP 66, Colour: Grey

Article number	Article name	GTIN (EAN)	Packaging unit
28593.6	KDS-DEG 31-32 GR	4044211215583	10 ST



Seal, Mounting type: Plug in, Length x width: 42.8 mm, Max. cable diameter: 33 mm, IP 66, Colour: Grey

Article number	Article name	GTIN (EAN)	Packaging unit
28594.6	KDS-DEG 32-33 GR	4044211215606	10 ST



Seal, Mounting type: Plug in, Length x width: 42.8 mm, Max. cable diameter: 34 mm, IP 66, Colour: Black

Article number	Article name	GTIN (EAN)	Packaging unit
28730.4	KDS-DEG 33-34 BK	4044211220969	10 ST



Seal, Mounting type: Plug in, Length x width: 42.8 mm, Max. cable diameter: 34 mm, IP 66, Colour: Grey

Article number	Article name	GTIN (EAN)	Packaging unit
28731.6	KDS-DEG 33-34 GR	4044211220976	10 ST

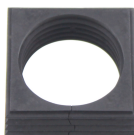

Seal, Mounting type: Plug in, Length x width: 42.8 mm, Max. cable diameter: 35 mm, IP 66, Colour: Black

Article number	Article name	GTIN (EAN)	Packaging unit
28732.4	KDS-DEG 34-35 BK	4044211220983	10 ST



Seal, Mounting type: Plug in, Length x width: 42.8 mm, Max. cable diameter: 35 mm, IP 66, Colour: Grey

Article number	Article name	GTIN (EAN)	Packaging unit
28733.6	KDS-DEG 34-35 GR	4044211220990	10 ST

28661.4 KDS-FP 3x10/24 BK

Big Seals



Seal, Mounting type: Plug in, Length x width: 42.8 mm, Max. cable diameter: 23 mm, IP 66, Colour: Black

Article number	Article name	GTIN (EAN)	Packaging unit
28543.4	KDS-DEG 22-23 BK	4044211215415	10 ST



Seal, Mounting type: Plug in, Length x width: 42.8 mm, Max. cable diameter: 24 mm, IP 66, Colour: Black

Article number	Article name	GTIN (EAN)	Packaging unit
28554.4	KDS-DEG/K 7-24 BK	4044211216108	10 ST



Seal, Mounting type: Plug in, Length x width: 42.8 mm, Max. cable diameter: 24 mm, IP 66, Colour: Grey

Article number	Article name	GTIN (EAN)	Packaging unit
28585.6	KDS-DEG 23-24 GR	4044211215422	10 ST



Seal, Mounting type: Plug in, Length x width: 42.8 mm, Max. cable diameter: 25 mm, IP 66, Colour: Grey

Article number	Article name	GTIN (EAN)	Packaging unit
28586.6	KDS-DEG 24-25 GR	4044211215446	10 ST



Seal, Mounting type: Plug in, Length x width: 42.8 mm, Max. cable diameter: 26 mm, IP 66, Colour: Grey

Article number	Article name	GTIN (EAN)	Packaging unit
28587.6	KDS-DEG 25-26 GR	4044211215477	10 ST



Seal, Mounting type: Plug in, Length x width: 42.8 mm, Max. cable diameter: 27 mm, IP 66, Colour: Grey

Article number	Article name	GTIN (EAN)	Packaging unit
28588.6	KDS-DEG 26-27 GR	4044211215484	10 ST



Seal, Mounting type: Plug in, Length x width: 42.8 mm, Max. cable diameter: 28 mm, IP 66, Colour: Grey

Article number	Article name	GTIN (EAN)	Packaging unit
28589.6	KDS-DEG 27-28 GR	4044211215507	10 ST

28661.4 KDS-FP 3x10/24 BK

Big Seals



Seal, Mounting type: Plug in, Length x width: 42.8 mm, Max. cable diameter: 29 mm, IP 66, Colour: Grey

Article number	Article name	GTIN (EAN)	Packaging unit
<u>28590.6</u>	KDS-DEG 28-29 GR	4044211215521	10 ST



Seal, Mounting type: Plug in, Length x width: 42.8 mm, Max. cable diameter: 30 mm, IP 66, Colour: Grey

Article number	Article name	GTIN (EAN)	Packaging unit
<u>28591.6</u>	KDS-DEG 29-30 GR	4044211215545	10 ST



Seal, Mounting type: Plug in, Length x width: 42.8 mm, Max. cable diameter: 31 mm, IP 66, Colour: Grey

Article number	Article name	GTIN (EAN)	Packaging unit
<u>28592.6</u>	KDS-DEG 30-31 GR	4044211215569	10 ST



Seal, Mounting type: Plug in, Length x width: 42.8 mm, Max. cable diameter: 19 mm, IP 66, Colour: Black

Article number	Article name	GTIN (EAN)	Packaging unit
<u>28539.4</u>	KDS-DEG 18-19 BK	4044211215330	10 ST



Seal, Mounting type: Plug in, Length x width: 42.8 mm, Max. cable diameter: 21 mm, IP 66, Colour: Black

Article number	Article name	GTIN (EAN)	Packaging unit
<u>28541.4</u>	KDS-DEG 20-21 BK	4044211215378	10 ST



Seal, Mounting type: Plug in, Length x width: 42.8 mm, Max. cable diameter: 22 mm, IP 66, Colour: Black

Article number	Article name	GTIN (EAN)	Packaging unit
<u>28542.4</u>	KDS-DEG 21-22 BK	4044211215392	10 ST

Actuating tool

28661.4 KDS-FP 3x10/24 BK



Using the KDS BW1 actuating tool, the seals can be conveniently mounted in and dismantled from the frame. The ergonomic grip and the special shape enable simple and precise installations, especially for cabling applications in confined spaces., Material: Polyamide

Article number	Article name	GTIN (EAN)	Packaging unit
<u>28622.0</u>	KDS BW 1	4044211216597	1 ST

Locking mechanism



Inner lock, Mounting type: Plug in

Article number	Article name	GTIN (EAN)	Packaging unit
<u>28664.3</u>	KDS-FP-IVR OG	4044211220402	20 ST

EMC brackets



Shield-connection rail enabling mounting of shield connection clips directly on cable entry system KDS-FP, Mounting type: Screw, Length: 35,3 mm, Width: 152 mm, Height: 16 mm, Profile: 10x3 mm

Article number	Article name	GTIN (EAN)	Packaging unit
<u>28627.0</u>	KDS-FP-EMV-SAB 10/24	4044211226657	1 ST

Inlays



Cable entry, Inlay, Mounting type: Plug in, IP 66, Colour: Black

Article number	Article name	GTIN (EAN)	Packaging unit
<u>28516.4</u>	KDS-Inlay 1 BK	4044211210847	5 ST



Cable entry, Inlay, Mounting type: Plug in, IP 66, Colour: Black

Article number	Article name	GTIN (EAN)	Packaging unit
<u>28517.4</u>	KDS-Inlay 2 BK	4044211210854	5 ST

28661.4 KDS-FP 3x10/24 BK

Inlays



Cable entry, Inlay, Mounting type: Plug in, IP 66, Colour: Black

Article number	Article name	GTIN (EAN)	Packaging unit
28518.4	KDS-Inlay 4 BK	4044211210861	5 ST



Cable entry, Inlay, Mounting type: Plug in, IP 66, Colour: Black

Article number	Article name	GTIN (EAN)	Packaging unit
28519.4	KDS-Inlay 6 BK	4044211210014	5 ST

Inner cover

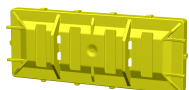

Inner cover for unused openings in the flange plates KDS-FP, Mounting type: plug-in, length: 153 mm, width: 55 mm, height: 11.5 mm, Material: Polyamide 6.6

Article number	Article name	GTIN (EAN)	Packaging unit
28665.8	KDS-FP-AD/UL YE	4044211234034	10 ST