



LINKWELL[®]
ELECTRIC



ENCLOSURES AND BOXES SERIES

WATERPROOF DISTRIBUTION BOX

It is applicable for special waterproof, dustproof and corrosion-proof locations
Executive standard: IEC60529 IP65 EN60309



IP65 CE

LK107-4P

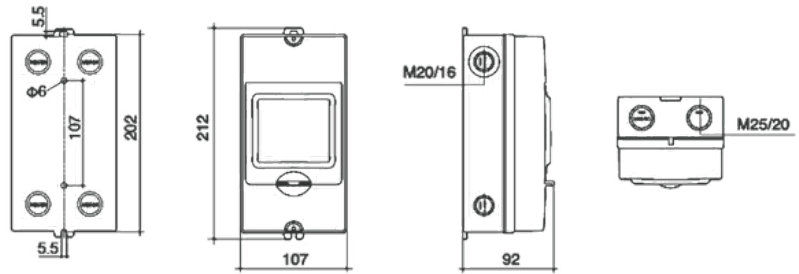

LK165-6P

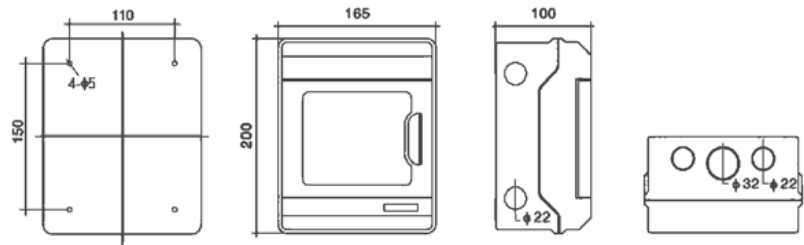

LK219-9P

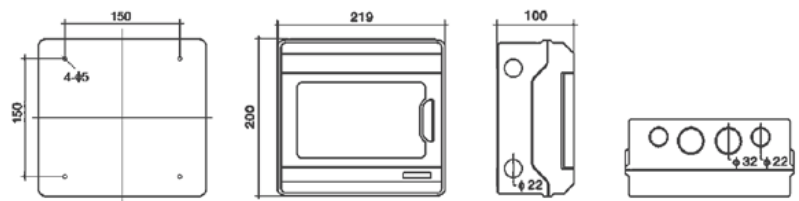

LK273-12P

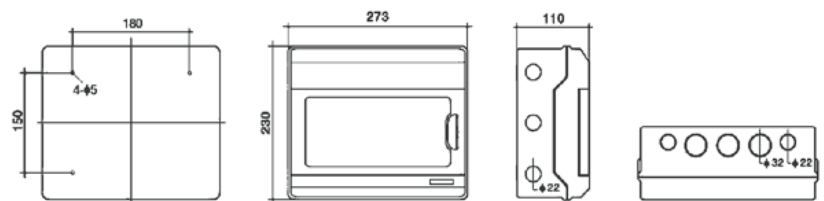

IP65 CE

LK381-18P

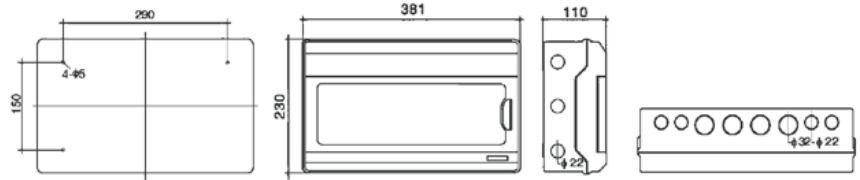

LK273-24P

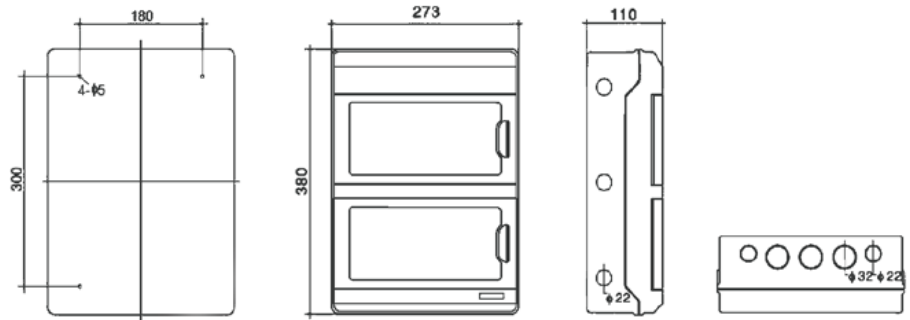

LK273-36P

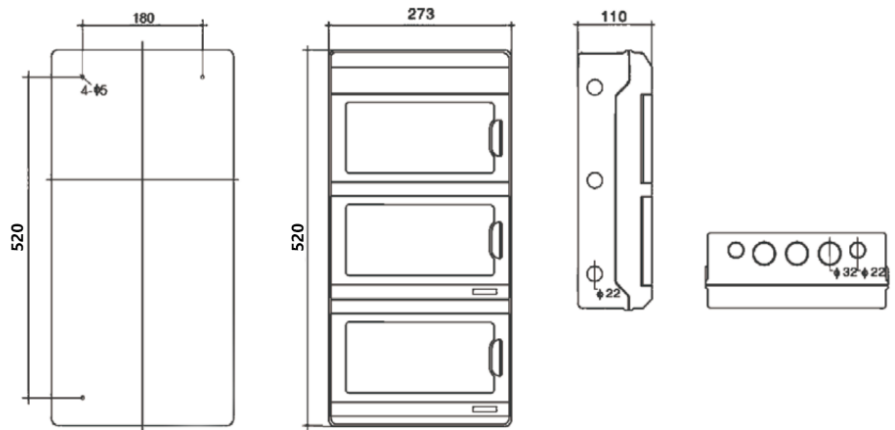



COVER PLATE FOR DLN SIZED OPENINGS

Cover plates are made of polycarbonate.

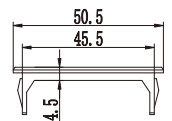

STK CODE	PRODUCT CODE	TYPE	WEIGHT (G)	PACKAGE (PCS)
33 501 70	0D02-0030	Closed	12	100

IP65 CE

LK1515

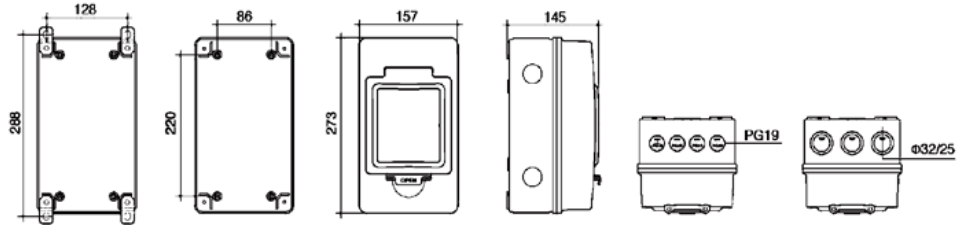

LK1515-63A

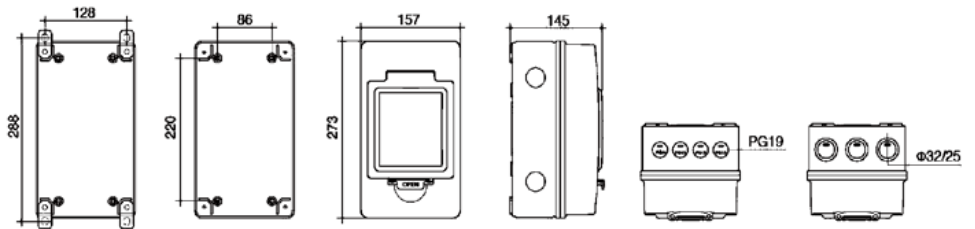

LK1515-125A

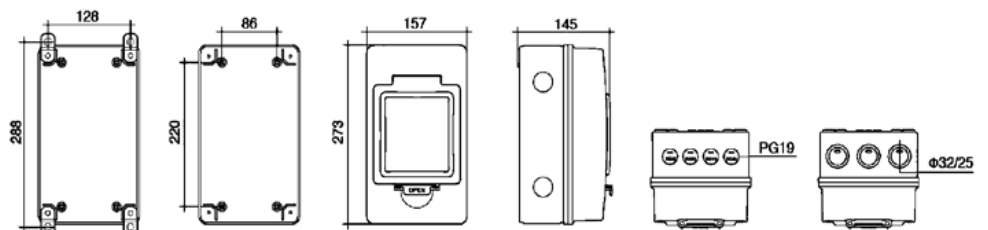

IP65 CE

LK1515-160A

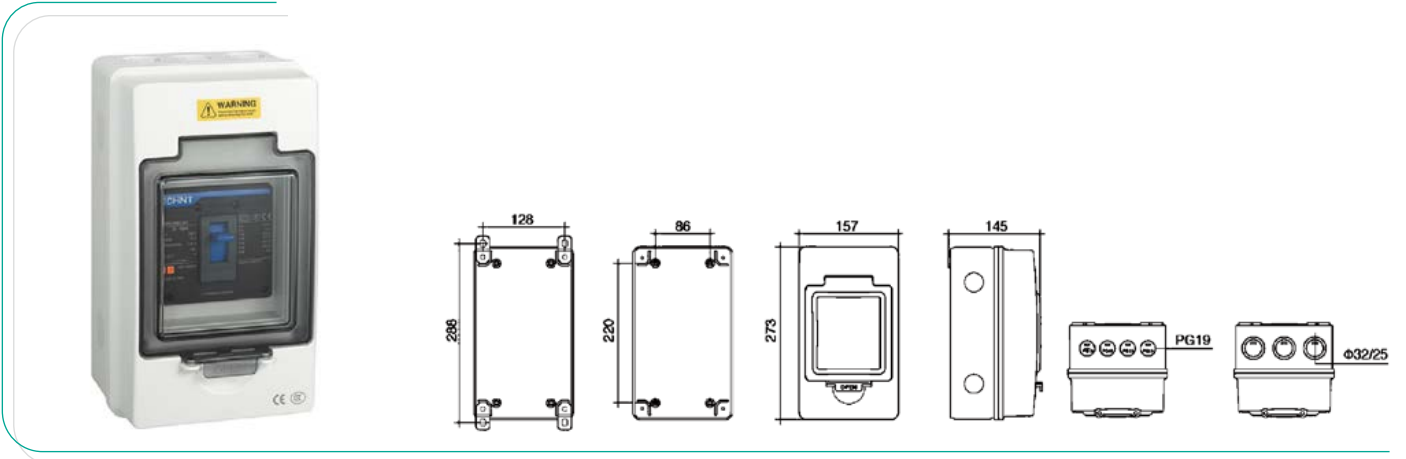

Internal neutral and grounding terminals
Ø8 European style wiring handle



Hanging corner accessories



LK SERIES

WATERPROOF DISTRIBUTION BOX (IP65)

LK Series lighting box is in line with IEC-493-1 standard, attractive and durable, safe and reliable, which is widely used in various places such as factory, mansion, residence, shopping center and so on.



LK SERIES WATERPROOF DISTRIBUTION BOX (IP65)



- Panel is the ABS material for the engineering, high strength, never change color, the transparent material is PC.

- Cover push-type opening and closing

Face covering of the distribution box adopts the push-type opening and closing mode, the face mask can be opened by pressing lightly, the self-locking positioning hinge structure is provided when opening.

- Wiring design of the power distribution box

The guide rail support plate can be lifted to the highest movable point, it is no longer limited by the narrow space when installing the wire. To install easily, the switch of the distribution box is set up with the wire groove and wire pipe exit-holes, which are easy to use for a variety of wire grooves and wire pipes.

PRODUCT SIZE

		MODEL	DIMENSION		
			L (mm)	W (mm)	H (mm)
		LK-4P	143	210	100
		LK-8P	215	210	140
		LK-12P	298	260	140
		LK-18P	410	285	140
		LK-24P	298	420	140
		LK-36P	298	570	140

LK0012B

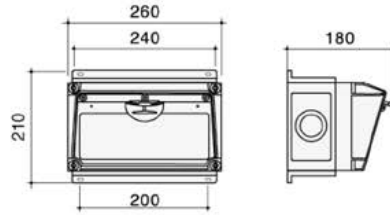

LK0048B



LK0024B

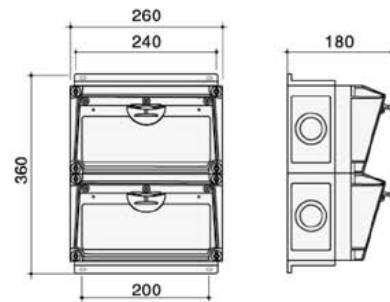

LK0036B

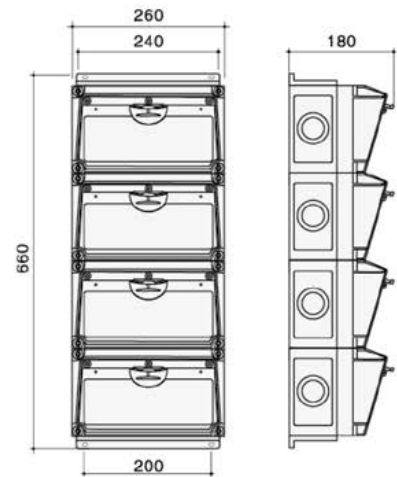
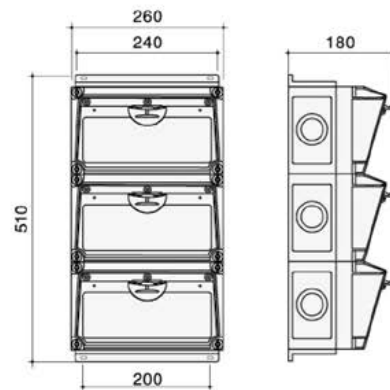

LK0012

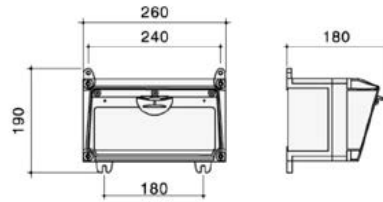

LK0048



LK0024

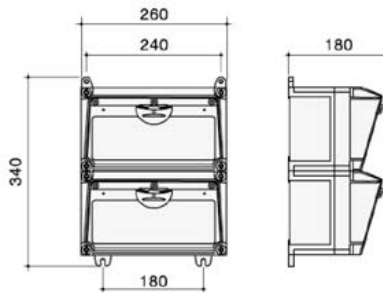

LK0036

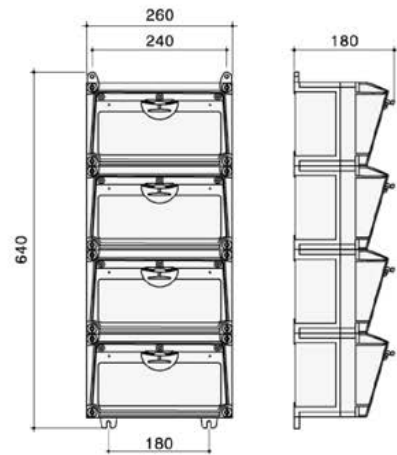
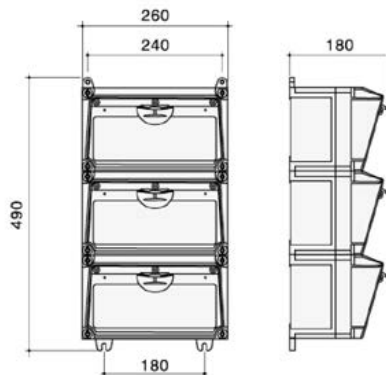



STAINLESS STEEL HINGE TYPE ELECTRICAL BOX

SERIES

Waterproof, dustproof, corrosion-resistant, high-strength insulation.

Holes can be opened at will according to user requirements, with complete specifications and convenient installation.

Executive standard: IEC60529 IP65 EN60309

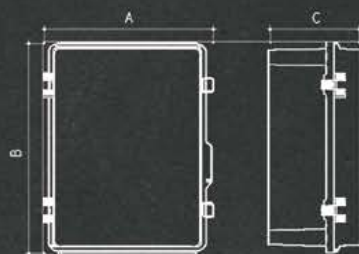

MODEL	OVERALL DIMENSION		
	A	B	C
LK101590	100	150	90
LK121790	125	175	90
LK151590	150	150	90
LK162110	160	210	100
LK172711	175	275	110
LK203013	200	300	130
LK253515	250	350	150
LK334318	330	430	180
LK435320	430	530	20
LK436323	430	630	230
LK537325	530	730	250
LK638328	630	830	280

IP65 CE



IP65 CE

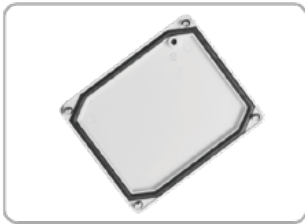
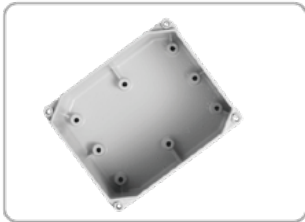

KPA9



KPA11



KPA12



KPA13



KPA16



KPA15



KPA14



MODEL	A	B	C	D	E	F	G	H	I	L	M	N	P	Q
KPA9	100	100	59	88	88	66	70.5	10	53	44	-	-	48	65
KPA11	115	140	61	128	103	107	66	10	55	46	-	-	90	81
KPA12	141	166	64	153	128	121	99	12.5	58	49	-	-	104	100
KPA13	168	192	80	176	152	153	113	10	74	65	-	-	128	125
KPA14	217	253	93	236	201	188	153	12.5	85	75	38	21	169	162
KPA15	264	314	122	292	243	238	198	12.5	114	106	49	24	203	192
KPA16	315	410	150	386	291	333	248	12.5	141	126	61	31	295	246

KPA9

KPA9 Dimensions, mounting holes, and mounting hole positions

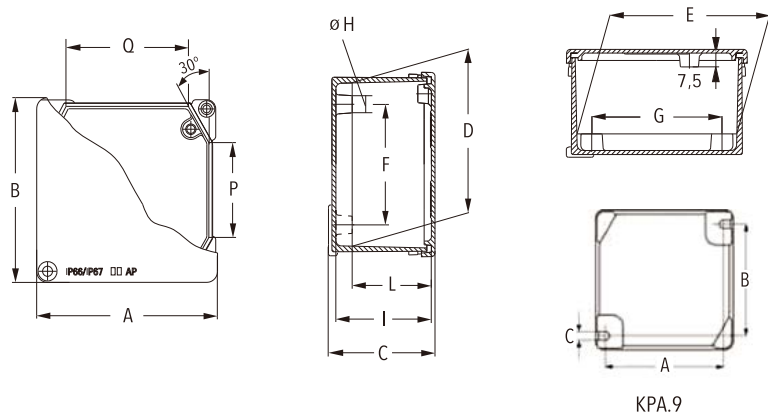

KPA11/12/13/14/15/16

KPA11/12/13/14/15/16 Dimensions, mounting holes, and mounting hole positions

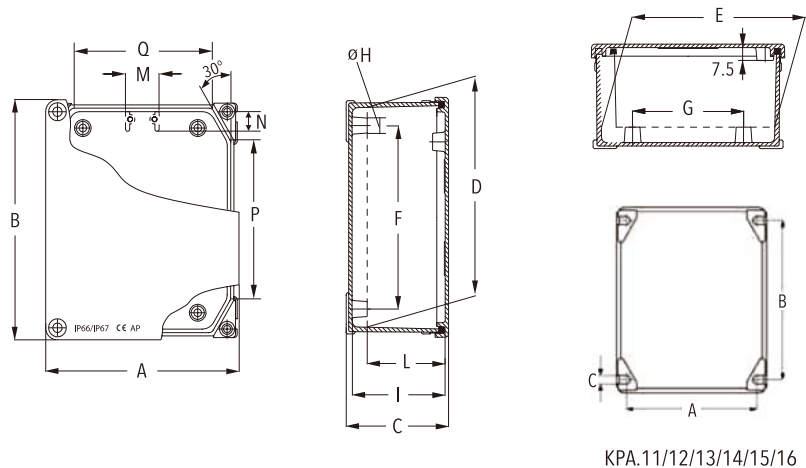

LK SERIES
CAST ALUMINUM BOX



DIN rail terminal block



Cable gland



Mounting plate



Invisible hinge, Earthing part

IP65 CE



MODEL	ORDER NUMBER	L(MM)	W(MM)	D(MM)
LK080807	510.080807	80	80	65
LK140806	510.140806	140	80	60
LK161007	510.161007	160	100	70
LK161609	510.161609	160	160	90
LK221208	510.221208	220	120	80
LK261609	510.261609	260	160	90
LK271509	510.271509	270	150	90
LK282311	510.282311	280	230	110
LK332312	510.332312	330	230	120
LK402311	510.402311	400	230	110

DIMENSION (mm)

LK080807 product dimensions and mounting hole location

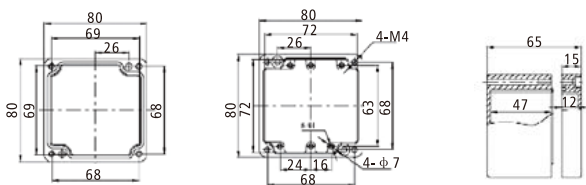

LK140806 product dimensions and mounting hole location

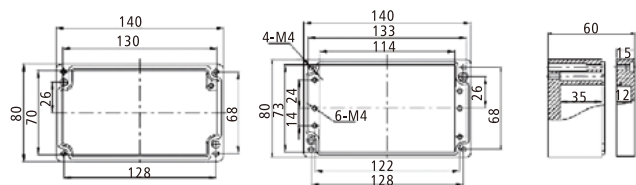

LK161007 product dimensions and mounting hole location

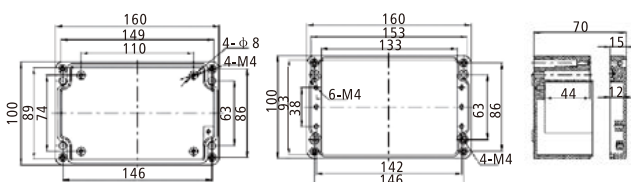

LK161609 product dimensions and mounting hole location

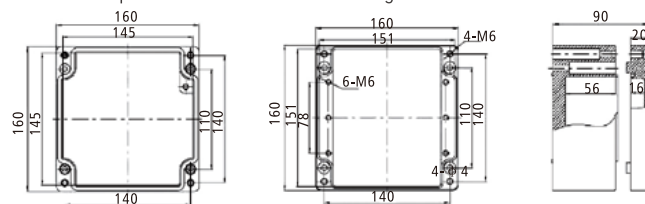

ECONOMICAL WATERPROOF ELECTRICAL BOX



IP65 CE

ELECTRICAL BOX

SERIES

MODEL	OVERALL DIMENSION		
	A	B	C
LK586435	58	64	35
LK081170	80	110	70
LK081370	80	130	70
LK081870	80	180	70
LK082570	80	250	70
LK101075	100	100	75
LK121275	125	125	75
LK121775	125	175	75
LK151575	150	150	75
LK152010	150	200	100
LK152013	150	200	130
LK152510	150	250	100
LK152513	150	250	130
LK202010	200	200	100
LK202013	200	200	130
LK192813	190	280	130
LK282813	280	280	130
LK283813	280	380	130

LK EUROPEAN SERIES

IP65 CE



Waterproof, dust-proof, anti-corrosion, strong installation.
Any open way can be customized according to customer needs,
specifications Complete and easy to install.

Implementation standard: IEC60529 IP65 EN60309



LK EUROPEAN SERIES
WATER PROOF ELECTRIC BOX

LK223415



Size: 220x300x150mm

LK304016



Size: 300x400x160mm

LK305216



Size: 300x520x160mm

LK274616



Size: 270x460x160mm

LK365418



Size: 360x540x180mm

LK233316



Size: 230x330x160mm

LK282816



Size: 280x280x160mm

LK363616



Size: 360x360x160mm

LK608022



Size: 600x800x220mm

LK EUROPEAN SERIES

IP65 CE



DIMENSION (mm)

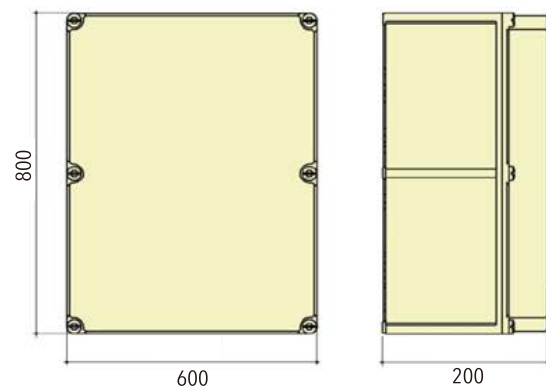

LK EUROPEAN SERIES
WATER PROOF ELECTRIC BOX

LK3020173



LK3020173-T



Size: 300x200x170mm

LK4030173-T



LK4030173



Size: 400x300x170mm

LK5040203



LK5040203-T



Size: 500x400x200mm

LK6040223-T



LK6040223



Size: 600x400x220mm

ADVANCED PLASTIC WATERPROOF BOX

IP67 CE



Product feature

1. The connecting bolts of LK-AGS junction box are made of injection molding, which have sufficient strength when connected to the boxRupture.
 2. The four-sided sliding mode is designed to combat the influence more effectively
- IP level: IP67
 Impact level: IK08
 Temperature range: ABS-40 ~ +70°C, polycarbonate (PC) : -40~+110°C
 Flammability: ABS 94-HB; Polycarbonate (PC) : 94-V-0,5VA,HB

Characteristic

- ABS acrylonitrile tributadiene styrene polycarbon
- PC/ABS acrylonitrile butadiene styrene
- PC: polycarbonate
- Note: Transparent/grey

Engraving/printing/custom development services

- Engraving treatment service
Meet the various needs of customers, through the accumulation of experience on the basis of precision hole machining technology
- Screen printing and letter engraving services
Exquisite screen printing and letter engraving process, make your products more outstanding
- Non-standard custom development services
According to customer requirements, provide a variety of procedures, the development of non - standard client

LK-AGS MODEL AND NAMING METHODS

IDENTIFY

Model name:
LK-UVW-XYZ series; [U=A.P.C; V=G.T; W=S; X=05-20; Y=06-20; Z=05-13]

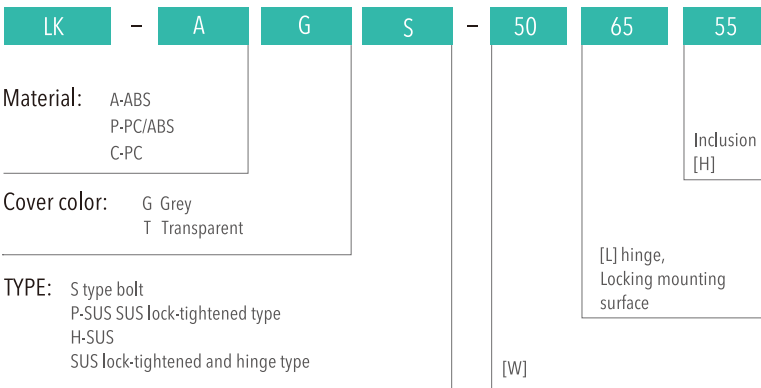
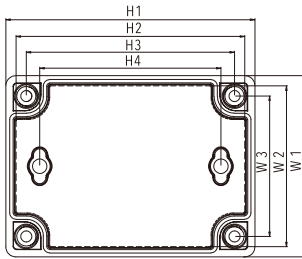

PLATE MODEL	SIZE[mm]	ABS	ABS/PC	PC	PC
plastic	Width/Length/Height	Grey cover	Transparent cover	Grey cover	Transparent cover
--	50x65x55	LK-AGS-060505	LK-PTS-060505	LK-CGS-060505	LK-CTS-060505
--	65x95x55	LK-AGS-090605	LK-PTS-090605	LK-CGS-090605	LK-CTS-090605
LK-0811P	80x110x70	LK-AGS-110807	LK-PTS-110807	LK-CGS-110807	LK-CTS-110807
LK-0811P	80x110x85	LK-AGS-110808	LK-PTS-110808	LK-CGS-110808	LK-CTS-110808
LK-0813P	80x130x70	LK-AGS-130807	LK-PTS-130807	LK-CGS-130807	LK-CTS-130807
LK-0813P	80x130x85	LK-AGS-130808	LK-PTS-130808	LK-CGS-130808	LK-CTS-130808
LK-0818P	80x180x70	LK-AGS-180807	LK-PTS-180807	LK-CGS-180807	LK-CTS-180807
LK-0825P	80x250x70	LK-AGS-250807	LK-PTS-250807	LK-CGS-250807	LK-CTS-250807
LK-0825P	80x250x85	LK-AGS-250808	LK-PTS-250808	LK-CGS-250808	LK-CTS-250808
LK-1010P	100x100x75	LK-AGS-101007	LK-PTS-101007	LK-CGS-101007	LK-CTS-101007
LK-1212P	125x125x75	LK-AGS-121207	LK-PTS-121207	LK-CGS-121207	LK-CTS-121207
LK-1212P	125x125x100	LK-AGS-121210	LK-PTS-121210	LK-CGS-121210	LK-CTS-121210
LK-1217P	125x175x75	LK-AGS-171207	LK-PTS-171207	LK-CGS-171207	LK-CTS-171207
LK-1217P	125x175x100	LK-AGS-171210	LK-PTS-171210	LK-CGS-171210	LK-CTS-171210
LK-1417P	140x170x95	LK-AGS-171409	LK-PTS-171409	LK-CGS-171409	LK-CTS-171409
LK-1520P	150x200x100	LK-AGS-201510	LK-PTS-201510	LK-CGS-201510	LK-CTS-201510
LK-1520P	150x200x130	LK-AGS-201513	LK-PTS-201513	LK-CGS-201513	LK-CTS-201513
LK-1525P	150x250x100	LK-AGS-251510	LK-PTS-251510	LK-CGS-251510	LK-CTS-251510
LK-1525P	150x250x130	LK-AGS-251513	LK-PTS-251513	LK-CGS-251513	LK-CTS-251513
LK-1717P	175x175x100	LK-AGS-171710	LK-PTS-171710	LK-CGS-171710	LK-CTS-171710
LK-2020P	200x200x100	LK-AGS-202010	LK-PTS-202010	LK-CGS-202010	LK-CTS-202010
LK-2020P	200x200x130	LK-AGS-202013	LK-PTS-202013	LK-CGS-202013	LK-CTS-202013
LK-1928P	190x280x130	LK-AGS-192813	LK-PTS-192813	LK-CGS-192813	LK-CTS-192813

IP67 CE

INSTALLATION DIMENSIONS/APPLICABLE ACCESSORIES



Base

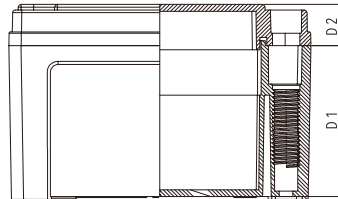

Cover the base

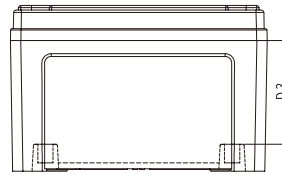

Cover the base

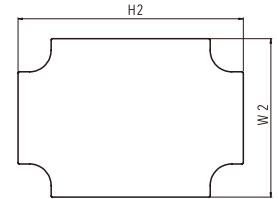

Mounting plate

ACCESSORIES



Plastic plate [ABS]



Plastic hinge [PB40]



Hinge [B40]



Bolts
[standard supply, CB40]



Screw

SIZE	SERIES	W1	W2	W3	H1	H2	H3	H4	D1	D2	D3
50x65x55		50	43	38	65	58	53	39.8	35	20	25.5
65x95x55		65	58	47	95	88	77	0	40	15	35.5
80x110x70		80	73	62	110	103	92	80	55	15	44.5
80x110x85		80	73	62	110	103	92	80	55	30	44.5
80x130x70		80	73	62	130	123	112	100	55	15	44.5
80x130x85		80	73	62	130	123	112	100	55	30	44.5
80x180x70		80	73	62	180	175	162	150	55	15	44.5
80x250x70		80	73	62	250	243	232	220	55	15	44.5
80x250x85		80	73	62	250	243	232	220	55	30	44.5
100x100x75		100	93	82	100	93	82	60	60	15	49.5
125x125x75		125	118	107	125	118	107	70	60	15	49.5
125x125x100		125	118	107	125	118	107	70	60	40	49.5
125x175x75		125	118	107	175	168	157	140	60	15	49.5
125x175x100		125	118	107	175	168	157	140	60	40	49.5
140x170x95		140	132	122	170	162	152	130	80	15	69
150x200x100		150	142	132	200	192	182	160	85	15	74
150x200x130		150	142	132	200	192	182	160	85	45	74
150x250x100		150	142	132	250	242	232	210	85	15	74
150x250x130		150	142	132	250	242	232	210	85	45	74
175x175x100		175	167	157	175	167	157	140	85	15	74
200x200x100		200	192	182	200	192	182	159.5	85	15	74
200x200x130		200	192	182	200	192	182	159.5	85	45	74

STAINLESS STEEL SCREW
TYPE ELECTRICAL BOX



STAINLESS STEEL SCREW TYPE ELECTRICAL BOX



STAINLESS STEEL SCREW TYPE

IP65 **CE**

LK858575

LK858575-T

Outline dimension, mounting hole and hole position diagram

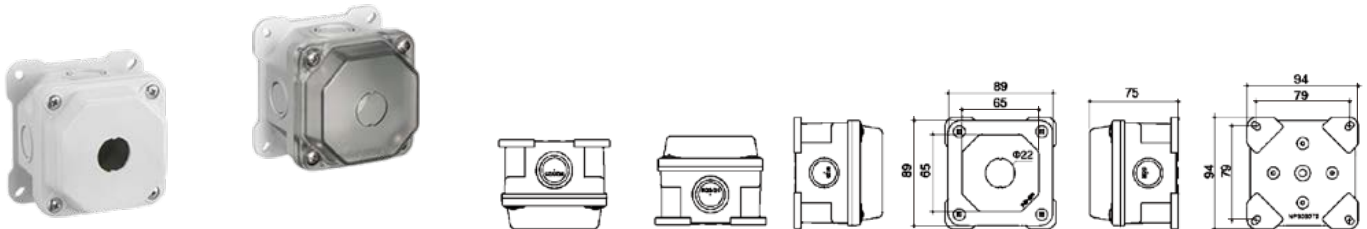

LK851475

LK851475-T

Outline dimension, mounting hole and hole position diagram

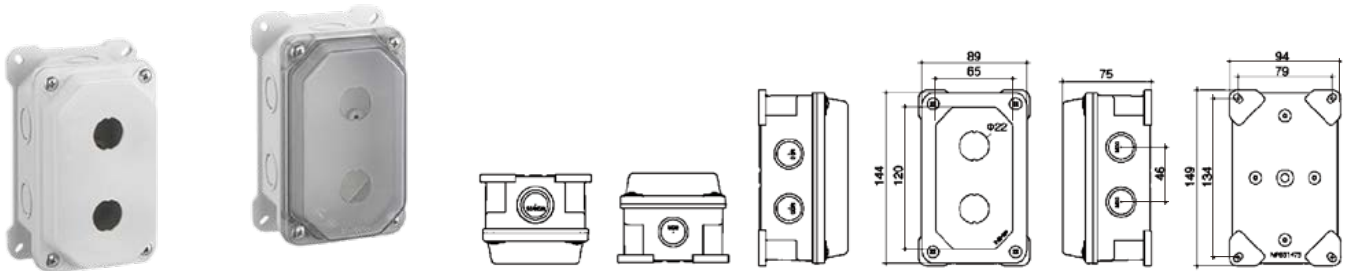

LK111180

LK111180-T

Outline dimension, mounting hole and hole position diagram

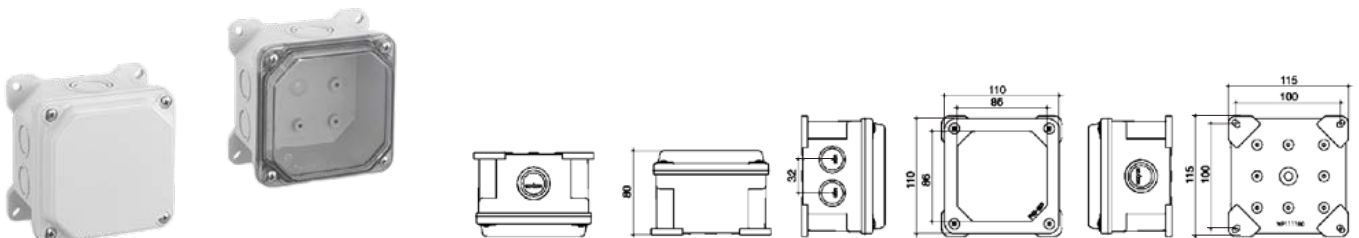

STAINLESS STEEL SCREW TYPE

IP65 CE

LK131390

LK131390-T

Outline dimension, mounting hole and hole position diagram

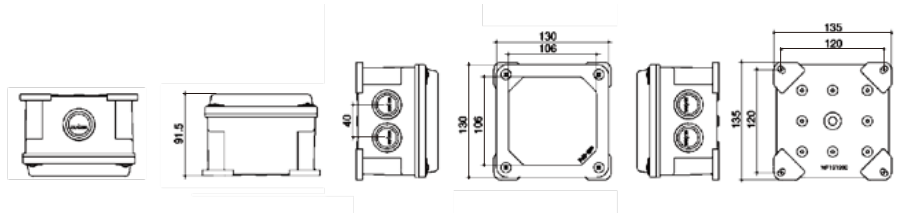

LK131890

LK131890-T

Outline dimension, mounting hole and hole position diagram

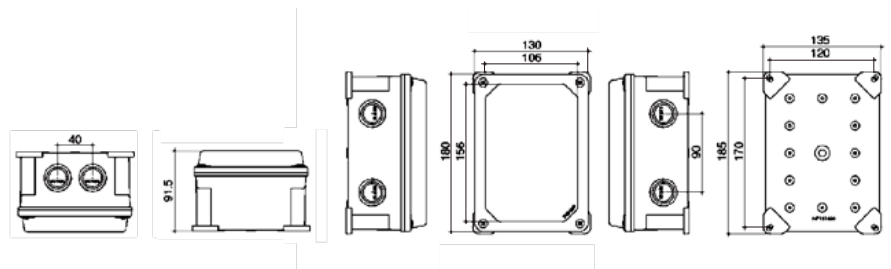

LK161690

LK161690-T

Outline dimension, mounting hole and hole position diagram

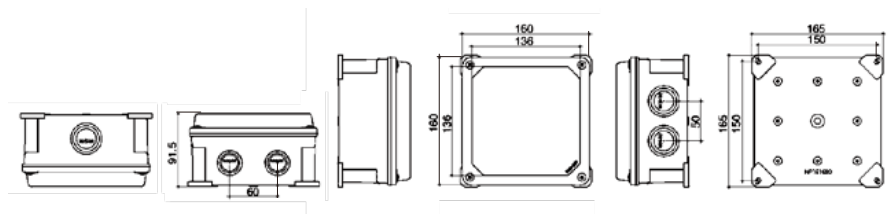

STAINLESS STEEL SCREW TYPE

IP65 CE

LK162111

LK162111-T

Outline dimension, mounting hole and hole position diagram

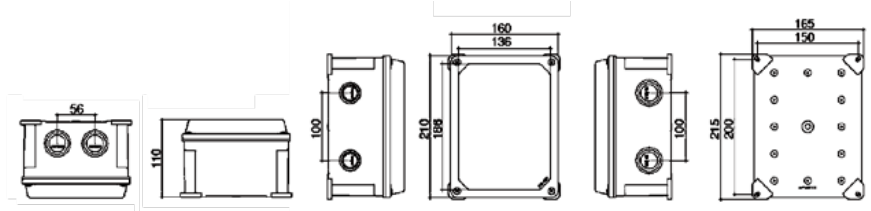

LK162112

LK162112-T

Outline dimension, mounting hole and hole position diagram

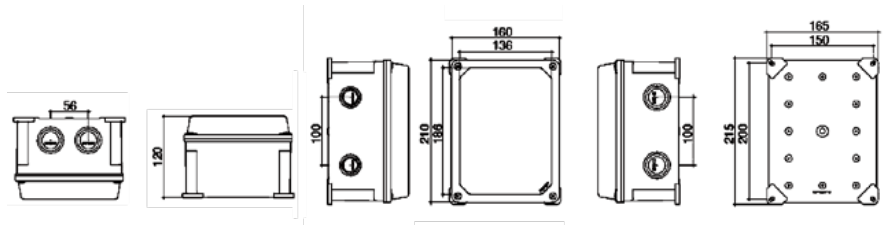

LK182511

LK182511-T

Outline dimension, mounting hole and hole position diagram

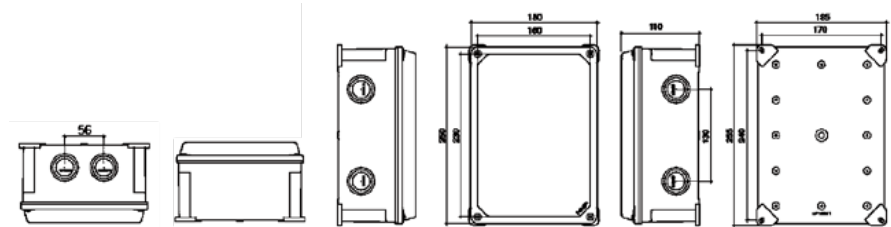

STAINLESS STEEL SCREW TYPE

IP65 CE

LK182512

LK182512-T

Outline dimension, mounting hole and hole position diagram

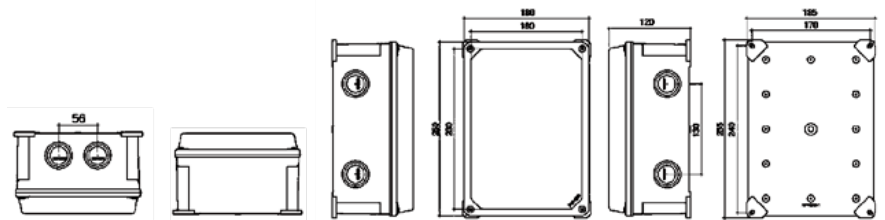

LK202011

LK202011-T

Outline dimension, mounting hole and hole position diagram

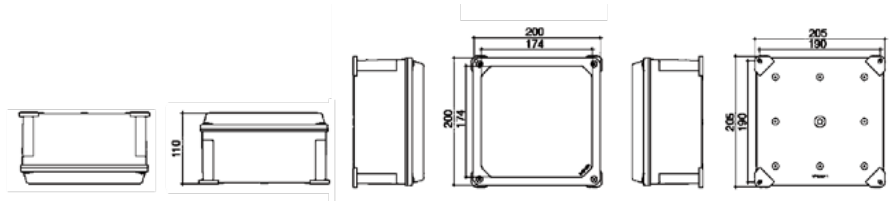

LK202012

LK202012-T

Outline dimension, mounting hole and hole position diagram

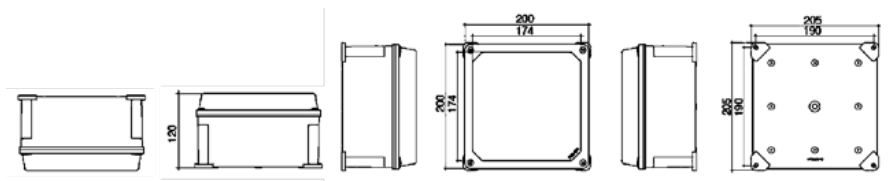

STAINLESS STEEL SCREW TYPE

IP65 **CE**

LK212911

LK212911-T

Outline dimension, mounting hole and hole position diagram

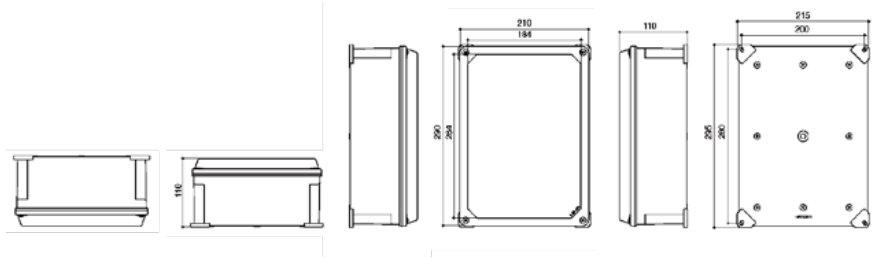

LK212912

LK212912-T

Outline dimension, mounting hole and hole position diagram

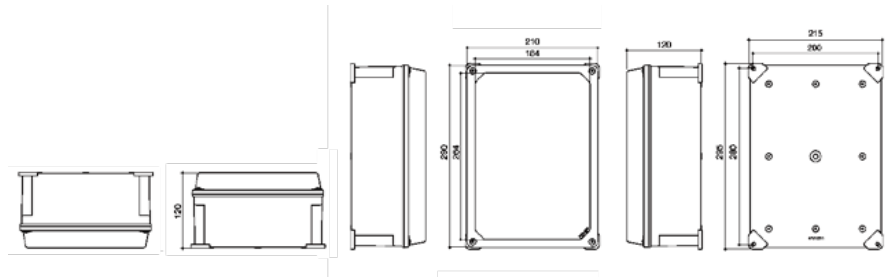

DISCONNECTORS

IP65 CE

- Load isolation switch with 3-pole
- With neutral and earthing points
- 4 cable holes of M16
- 8 cable holes of M20/M25

- Polycarbonate box body
- Protection level IP65
- Can be added with an interpole
- Can be added with M type auxiliary contact module



16-40A

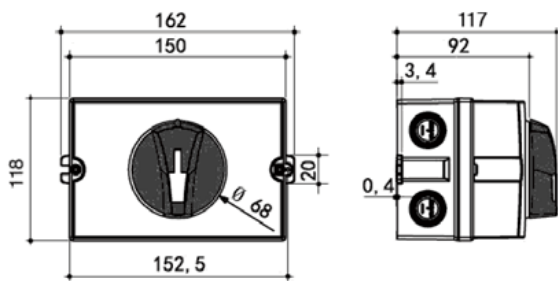

63-100A

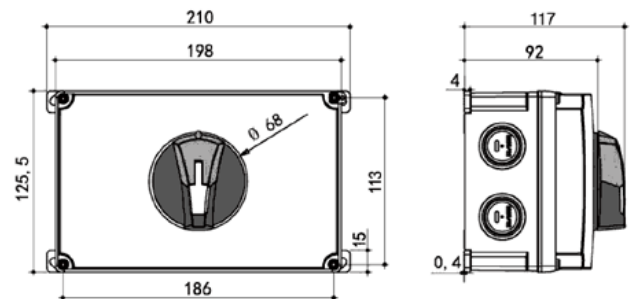

DISCONNECTORS

IP65 CE



NAME OF PRODUCT	CAPACITY	POLE	HANDLE COLOR	BOX COLOR
Empty Box	16...40	3	Black	Gray
	16...40	3	Red	Yellow
	63...80	3	Black	Gray
	63...80	3	Red	Yellow
With switch box	16	3	Black	Gray
	16	3	Red	Yellow
	20	3	Black	Gray
	20	3	Red	Yellow
	25	3	Black	Gray
	25	3	Red	Yellow
	32	3	Black	Gray
	32	3	Red	Yellow
	40	3	Black	Gray
	40	3	Red	Yellow
	63	3	Black	Gray
	63	3	Red	Yellow
	80	3	Black	Gray
	80	3	Red	Yellow
	100	3	Black	Gray
	100	3	Red	Yellow

STK SERIES TRANSPARENT PROTECTIVE WINDOW COVER

Indicator function

Grid-plate Separable design

Stainless steel screw
It can be tightened by hand

UL94V0 level

Integrated sealing ring
IP67 waterproof rating

Guide ring structure
Improve installation efficiency

Peripheral bulge
anti-bruising

Integrated sealing ring
IP67 waterproof rating



STK-02A

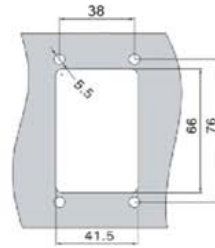
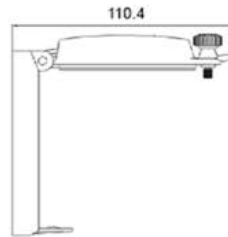
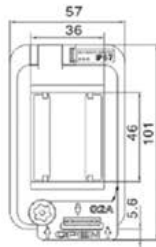

STK-03A

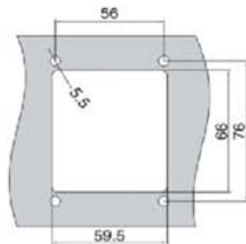
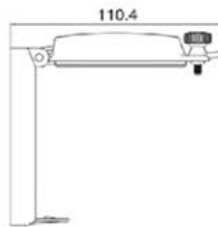
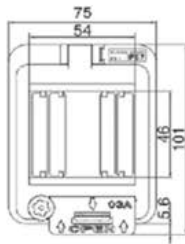

STK-04A

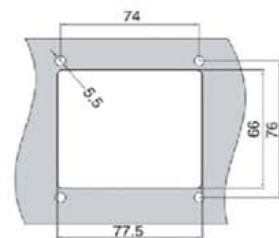
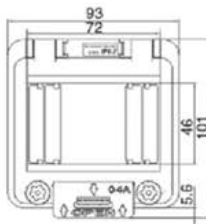

STK-05A

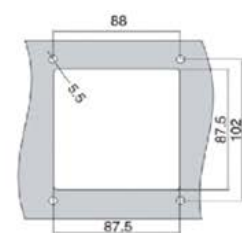
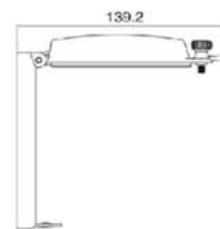
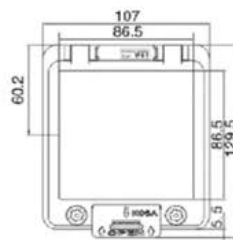

STK-06A

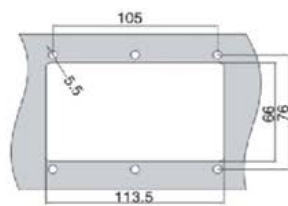
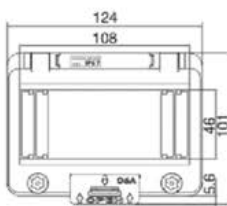

STK-08A

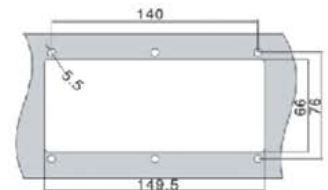
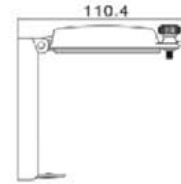
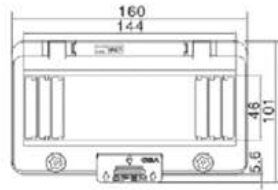

STK-10A

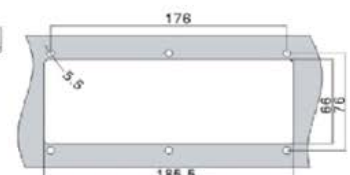
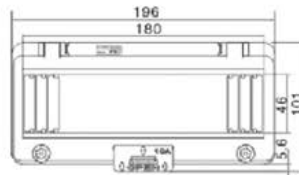

STK-12A

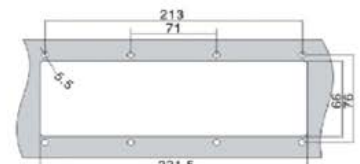

STK-13A

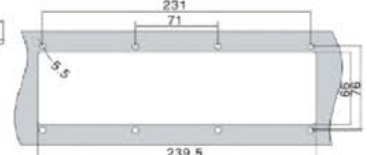
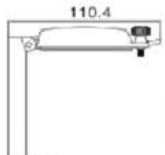
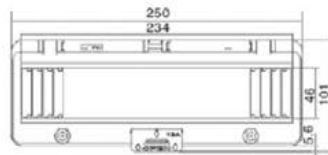

STK-16A

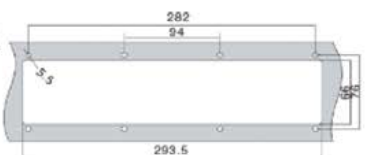
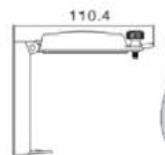
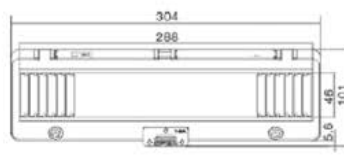

STK-18A

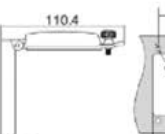
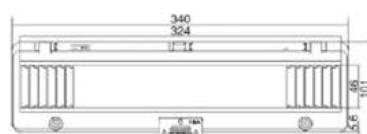

TRANSPARENT CONTACT PROTECTION WINDOW COVER

IP65 CE



LK4-04D

Outline dimension, mounting hole and hole position diagram of LK4-04D window product

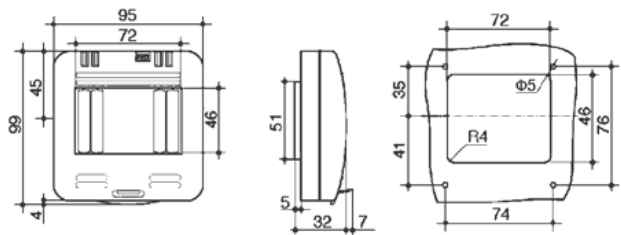

LK4-06D

Outline dimension, mounting hole and hole position diagram of LK4-06D window product

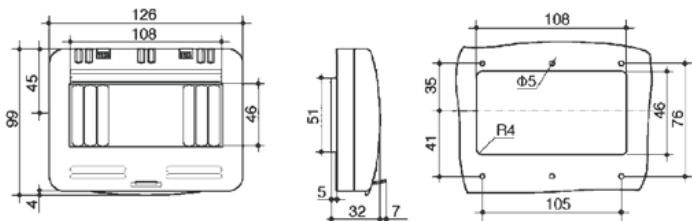

TRANSPARENT CONTACT PROTECTION WINDOW COVER

IP65 CE

LK4-08D

Outline dimension, mounting hole and hole position diagram of LK4-08D window product

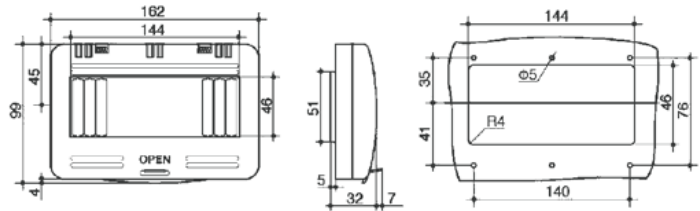

LK4-10D

Outline dimension, mounting hole and hole position diagram of LK4-10D window product

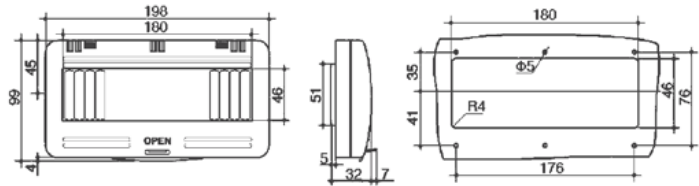

LK4-12D

Outline dimension, mounting hole and hole position diagram of LK4-12D window product

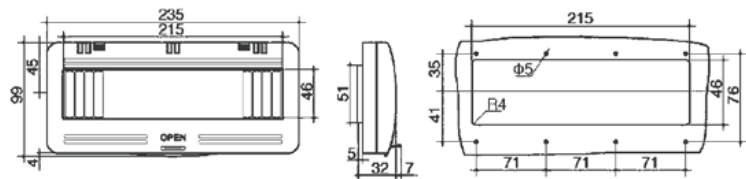

LK4-14D

Outline dimension, mounting hole and hole position diagram of LK4-14D window product

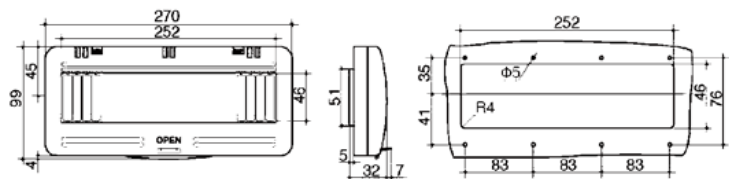

WATERPROOF WINDOW COVER OF CIRCUIT BREAKER

IP65 CE

Suitable for special occasions such as waterproof, dustproof, and anti-corrosion
Executive standards: IEC60529 IP65 EN60309



LK04-200

Outline dimension, mounting hole and hole position diagram of LK04-200 window product

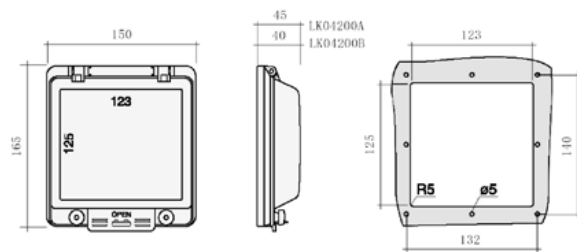

LK04-400

Outline dimension, mounting hole and hole position diagram of LK04-400 window product

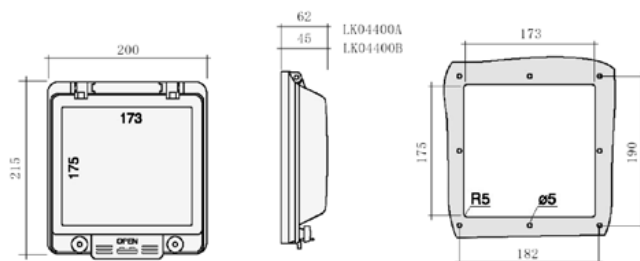

TRANSPARENT CONTACT PROTECTION WINDOW COVER

IP65 CE

LK4-26B



Outline dimension, mounting hole and hole position diagram of LK4-26B window product

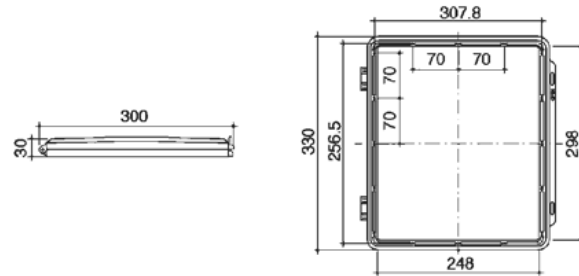

LK4-36B



Outline dimension, mounting hole and hole position diagram of LK4-36B window product

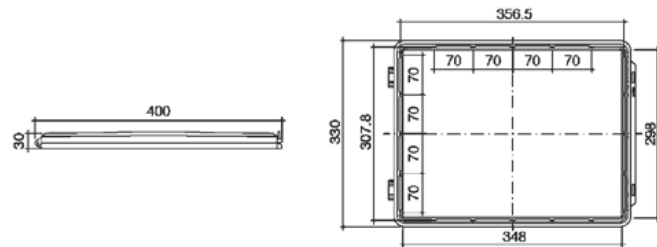

STK-D (02~18)

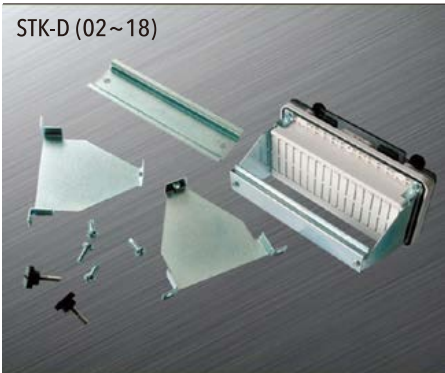

Bracket and Din-rail kit for STK window

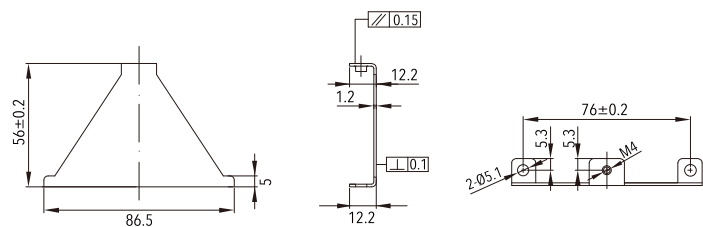

LK0908



Transparent window of distribution box LK0908

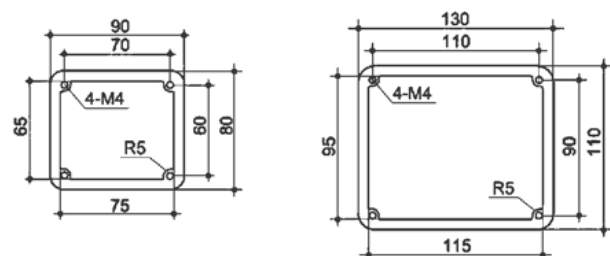

TOUCH SCREEN PROTECTIVE COVER 7 INCHES

IP65 CE



DIMENSION	SUITABLE FOR BRAND	TOUCH SCREEN MODEL
192x138mm	SIEMENS OMRON MITSUBISHI KUNLUNTONGTAI WEILUN SAMKOON YOUKONG INOVANCE KINCO FLEXEM HOLLYSYS XINJE	SMART700 IE V3 NB7W-TW11B NB7Q-TW00B/01B GS2107-WTBD TPC7062KD(HL/HN TK6071 IQ/IP TK8071 IE/IP MT6071 IE/IP MT8071 IP CMT3072 SK-070BE MM-30MR/40MR IT6070T IT6070E ET070 FE6070 HT8720T TG765
197x143mm	SIEMENS DELTA	YP177A KTP600 DOP-B07S410/07S411/07S415/07E411
211x145mm	HOLLYSYS SAMKOON	HT8700T HT8700TE SK-070AE/BC/AS
215x152mm	KUNLUNTONGTAI	TPC7062TD/KT TPC7062TX/KXTI

TOUCH SCREEN PROTECTIVE COVER 10 INCHES

IP65 CE



DIMENSION	SUITABLE FOR BRAND	TOUCH SCREEN MODEL
261x181mm	KUNLUNTONGTAI OMRON COOLMAY SOSU FLEXEM YOUKONG XINJE	TPC1061TD/TX/TT NA5-9W001B NA5-9W001S EX3G-100HA/HB SS-150WD FM6100C MM1001-52MR THA62 TGA63 TGC65

TOUCH SCREEN PROTECTIVE COVER 10.5 INCHES

IP65 CE



DIMENSION	SUITABLE FOR BRAND	TOUCH SCREEN MODEL
260x202mm	SIEMENS OMRON MITSUBISHI KUNLUNTONGTAI WEILUN	SMART1000 IE 6MART1000 IE V3 SMART1000IE 6AV6648-OCE11 NB10Q-TWO0B NB10Q-TWO1B GS2110-WTBD TPC1061HNTPC1162HN MT8103IE MT61011Q MT6013IP MT8101IE MT8102IP MT8012IE CMT3103 EMT3105P
255x202mm	YUANJUN	YJ150DZ
262x192mm	DELTA	DOP-B10S4LLDOP-B10S615
150x192mm	WEILUN	CMT3090 CMT-IV5 CMT-IPC10
260x205mm	RONGGE	RG-XSQ010

TOUCH SCREEN PROTECTIVE COVER 12 INCHES

IP65 CE



DIMENSION	SUITABLE FOR BRAND	TOUCH SCREEN MODEL
310x220mm	SIEMENS	TP1200 KTP1200



GLASS PANEL INTELLIGENT LIGHTING BOX

Injecting soul into every detail, LINKWELL innovative large flat glass panel information box is an artist's passionate work dedicated to reproducing pure texture combined with cutting-edge technology, drawing inspiration from nature, allowing every eye to freeze and enjoy a wonderful and diverse warm life

GLASS PANEL INTELLIGENT LIGHTING BOX



The distribution box is a tempered glass covered metal box, mainly used for :

- The electrical installation, supporting, and renovation building electrical distribution system.
- The installation method is the combination of metal box and plastic cover, which is particularly suitable for concealed installation of distribution boxes in buildings and decoration projects.
- The fashionable appearance design is suitable for high-end residential, hotel, and office buildings that showcase modern lifestyle taste
- Products that meet the standards have first obtained 3C certification and meet the standards of GB17466.1 and GB17466.24

MODEL	ROWS	SPECIFICATION	OVERALL DIMENSION	BOTTOM BOX SIZE
			mm	mm
LYB2-16	1	16	370x270x107	340x250x90
LYB2-20	1	20	442x270x107	412x250x90
LYB2-24	2	24	298x470x107	268x450x90
LYB2-32	2	32	370x470x107	340x450x90
LYB2-40	2	40	442x470x107	412x450x90
LYB2-48	3	48	370x670x107	340x650x90
LYB2-60	4	60	442x670x107	412x650x90



LINKWELL

Secondary line assembly groove

Hinge can be switched left and right

A8403Door lock

The box is double folded

Door panel is double folded

Galvanized base plate

Casting forming sealing ring or dispensing machine

Ground Wire

BlankingPlate



JXF SERIES CONTROL BOX



MODEL	OVERALL DIMENSION			TYPE/SPECIFICATION			
	W (mm)	H (mm)	D (mm)	A- type Box/mounting plate/door 1.4/1.5/1.7 (mm)	B- type Box/mounting plate/door 1.2/1.2/1.4 (mm)	C- type Box/mounting plate/door 1.0/1.0/1.2 (mm)	D- type Box/mounting plate/door 1.0/0.8/1.0 (mm)
JXF-300400/155	300	400	155	•	•	•	•
JXF-400500/155	400	500	155	•	•	•	•
JXF-400600/155	400	600	155	•	•	•	•
JXF-500600/155	500	600	155	•	•	•	•
JXF-500700/155	500	700	155	•	•	•	•
JXF-600700/155	600	700	155	•	•	•	•
JXF-600800/155	600	800	155	•	•	•	•
JXF-300400/210	300	400	210	•	•	•	•
JXF-400500/210	400	500	210	•	•	•	•
JXF-400600/210	400	600	210	•	•	•	•
JXF-500600/210	500	600	210	•	•	•	•
JXF-500700/210	500	700	210	•	•	•	•
JXF-600700/210	600	700	210	•	•	•	•
JXF-600800/210	600	800	210	•	•	•	•
JXF-700900/210	700	900	210	•	•	•	•
JXF-6001000/210	600	1000	210	•	•	•	•
JXF-8001000/210	800	1000	210	•	•	•	•
JXF-300400/250	300	400	250	•	•	•	•
JXF-400500/250	400	500	250	•	•	•	•
JXF-400600/250	400	600	250	•	•	•	•
JXF-500600/250	500	600	250	•	•	•	•
JXF-500700/250	500	700	250	•	•	•	•
JXF-600700/250	600	700	250	•	•	•	•
JXF-600800/250	600	800	250	•	•	•	•
JXF-700900/250	700	900	250	•	•	•	•
JXF-6001000/250	600	1000	250	•	•	•	•
JXF-8001000/250	800	1000	250	•	•	•	•
JXF-500600/300	500	600	300	•			
JXF-500700/300	500	700	300	•			
JXF-600700/300	600	700	300	•			
JXF-600800/300	600	800	300	•			
JXF-700900/300	700	900	300	•			
JXF-6001000/300	600	1000	300	•			
JXF-8001000/300	800	1000	300	•			

LK BRANCH TERMINAL BOX SERIES



LK171275-10/15P

Size: 175x125x75mm

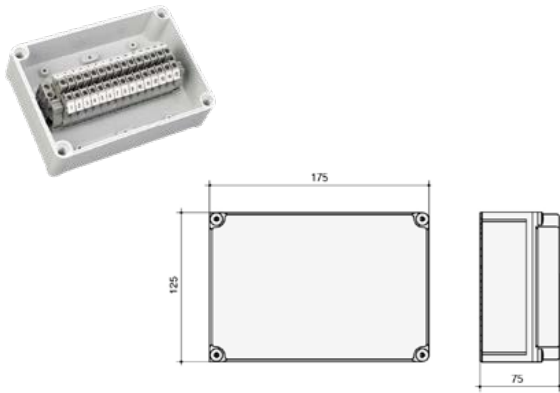

LK808052

Size: 80x80x52mm

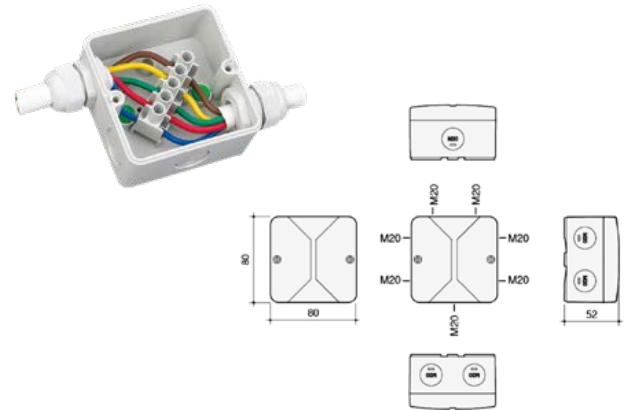

LK201510-15/20P

Size: 200x150x100mm

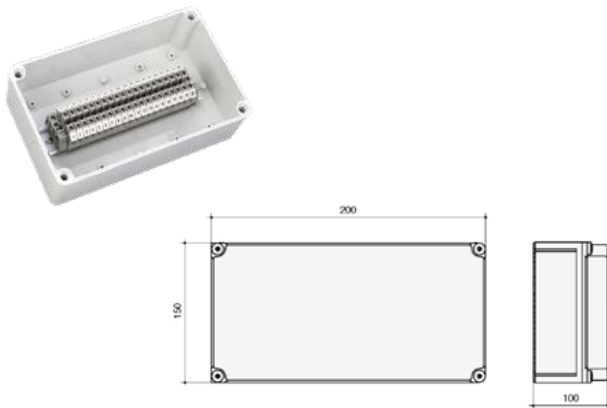

LK939355

Size: 93x93x55mm

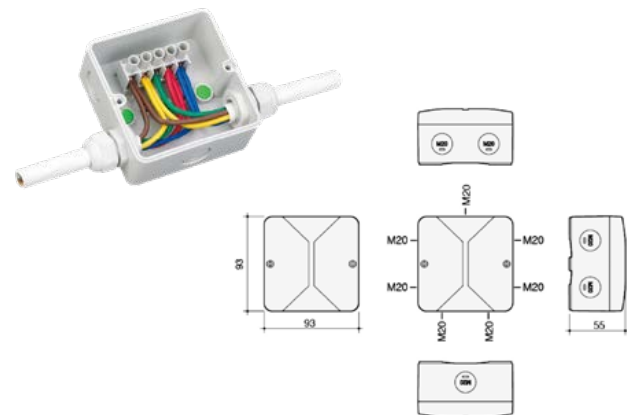

LK111167

Size: 110x110x67mm

