

NBC-M12MS/ 2,0-94B/R4AC US - Network cable



1406117

<https://www.phoenixcontact.com/au/products/1406117>

Please be informed that the data shown in this PDF document is generated from our online catalog. Please find the complete data in the user documentation. Our general terms of use for downloads are valid.

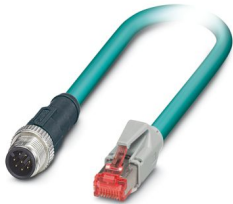

Network cable, Ethernet CAT5 (1 Gbps), 8-position, PUR halogen-free, water blue RAL 5021, shielded, Plug straight M12, coding: A / IP67, on Plug straight RJ45 / IP20, cable length: 2 m

Commercial data

Item number	1406117
Packing unit	1 pc
Minimum order quantity	50 pc
Note	Made to order (non-returnable)
Sales key	AF1IHB
Product key	AF1IHB
GTIN	4046356799324
Weight per piece (including packing)	114.2 g
Weight per piece (excluding packing)	119.9 g
Customs tariff number	85444290
Country of origin	US

1406117

<https://www.phoenixcontact.com/au/products/1406117>

Technical data

Product properties

Product type	Data cable preassembled
Application	Standard, U.S. cables
Sensor type	Ethernet
Number of positions	8
Shielded	yes
Coding	A

Interfaces

Bus system	Ethernet
Signal type/category	Ethernet CAT5 (based on IEC 11801), 1 Gbps

Signaling

Status display	no
Status display present	no

Electrical properties

Nominal voltage U_N	48 V AC
	60 V DC
Nominal current I_N	1 A
Transmission medium	Copper
Transmission characteristics (category)	CAT5 (IEC 11801:2002)

Connector

Connection 1

Type	Plug straight M12 / IP67
Coding type	A (Standard)
Material	CuSn (Contact)
	Ni/Au (Contact surface)
	PA (Contact carrier)
	TPU, hardly inflammable, self-extinguishing (Grip body)
	Zinc die-cast, nickel-plated (Screw connection)
Degree of protection	IP67

Connection 2

Type	Plug straight RJ45 / IP20
Material	CuSn (Contact)
	Ni/Au (Contact surface)
	PA (Contact carrier)
	PA (Housing)
Degree of protection	IP20

NBC-M12MS/ 2,0-94B/R4AC US - Network cable



1406117

<https://www.phoenixcontact.com/au/products/1406117>

Cable/line

Cable length	2 m
--------------	-----

Ethernet flexible CAT5, 4-pair [94B]

Dimensional drawing	
Cable weight	47 kg/km
UL AWM Style	20963 (80°C/30 V)
Number of positions	8
Shielded	yes
Cable type	Ethernet flexible CAT5, 4-pair [94B]
Conductor structure	4x2xAWG26/7, SF/UTP
Signal runtime	5.3 ns/m
Conductor structure signal line	7x 0.16 mm
AWG signal line	26
Conductor cross section	4x 2x 0.14 mm ²
Wire diameter incl. insulation	0.96 mm
External cable diameter	6.40 mm ±0.2 mm
Outer sheath, material	PUR
External sheath, color	water blue RAL 5021
Conductor material	Bare Cu litz wires
Material wire insulation	Foamed PE
Single wire, color	white/blue-blue, white/orange-orange, white/green-green, white/brown-brown
Thickness, outer sheath	1.05 mm
Twisted pairs	2 cores to the pair
Overall twist	4 pairs for core
Optical shield covering	70 %
Insulation resistance	≥ 5 GΩ*km
Coupling resistance	≤ 100.00 mΩ/m (at 10 MHz)
Loop resistance	≤ 290.00 Ω/km
Wave impedance	100 Ω ±5 Ω (at 100 MHz)
Cable capacity	48 nF/km (at 1 kHz)
Nominal voltage, cable	≤ 100 V
Test voltage Core/Core	700 V (50 Hz, 1 min.)
Test voltage Core/Shield	700.00 V (50 Hz, 1 min.)
Minimum bending radius, fixed installation	4 x D
Minimum bending radius, flexible installation	8 x D

NBC-M12MS/ 2,0-94B/R4AC US - Network cable



1406117

<https://www.phoenixcontact.com/au/products/1406117>

Smallest bending radius, fixed installation	26 mm
Smallest bending radius, movable installation	52 mm
Tensile strength	≤ 100 N
Near end crosstalk attenuation (NEXT)	71.3 dB (with 1 MHz)
	62.3 dB (at 4 MHz)
	56.3 dB (at 10 MHz)
	53.2 dB (at 16 MHz)
	51.8 dB (at 20 MHz)
	48.9 dB (at 31.25 MHz)
	44.4 dB (at 62.5 MHz)
	41.3 dB (at 100 MHz)
Power-summated near end crosstalk attenuation (PSNEXT)	62.3 dB (with 1 MHz)
	53.3 dB (at 4 MHz)
	47.3 dB (at 10 MHz)
	44.2 dB (at 16 MHz)
	42.8 dB (at 20 MHz)
	39.9 dB (at 31.25 MHz)
	35.4 dB (at 62.5 MHz)
	32.3 dB (at 100 MHz)
Return attenuation (RL)	23 dB (at 4 MHz)
	24.1 dB (at 8 MHz)
	25 dB (at 10 MHz)
	25 dB (at 16 MHz)
	25 dB (at 20 MHz)
	23.6 dB (at 31.25 MHz)
	21.5 dB (at 62.5 MHz)
	20.1 dB (at 100 MHz)
Shield attenuation	3.2 dB (with 1 MHz)
	6 dB (at 4 MHz)
	9.5 dB (at 10 MHz)
	12.1 dB (at 16 MHz)
	13.6 dB (at 20 MHz)
	17.1 dB (at 31.25 MHz)
	24.8 dB (at 62.5 MHz)
	32 dB (at 100 MHz)
Halogen-free	according to IEC 60754-1
Flame resistance	according to IEC 60332-1-2
Resistance to oil	in accordance with EN 60811-2-1
Ambient temperature (operation)	-40 °C ... 80 °C (cable, fixed installation)
	-20 °C ... 80 °C (Cable, flexible installation)
Ambient temperature (installation)	-20 °C ... 80 °C

Environmental and real-life conditions

NBC-M12MS/ 2,0-94B/R4AC US - Network cable



1406117

<https://www.phoenixcontact.com/au/products/1406117>

Ambient conditions

Degree of protection	IP65 (M12 connector)
	IP67 (M12 connector)
	IP20 (RJ45 connector)
	IP67/IP20
Ambient temperature (operation) (male connector/female connector)	-25 °C ... 85 °C (M12 connector)
	-25 °C ... 60 °C (RJ45 connector)

Standards and regulations

M12

Standard designation	M12 connector
Standards/specifications	IEC 61076-2-101

Drawings

Dimensional drawing

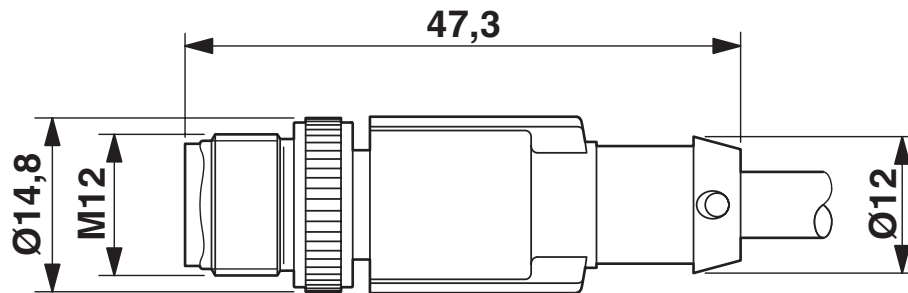

Plug, M12 x 1, straight, shielded

Dimensional drawing

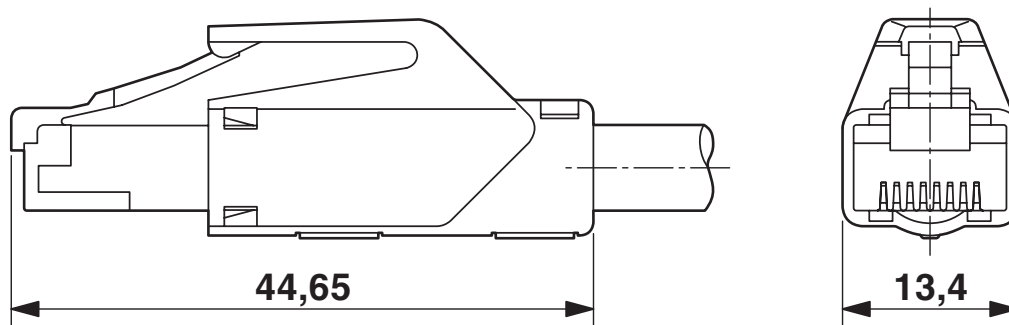

RJ45 connector, IP20

1406117

<https://www.phoenixcontact.com/au/products/1406117>

Schematic diagram

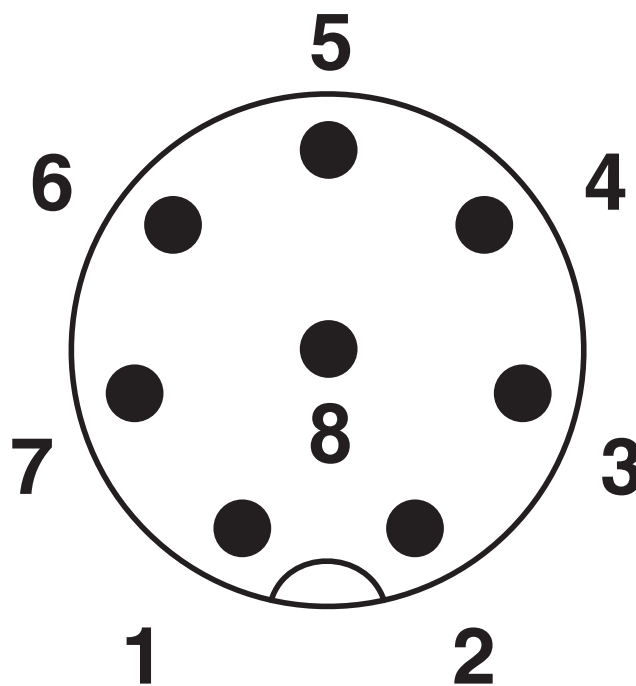

Pin assignment M12 plug, 8-pos., A-coded, view plug side

Schematic diagram

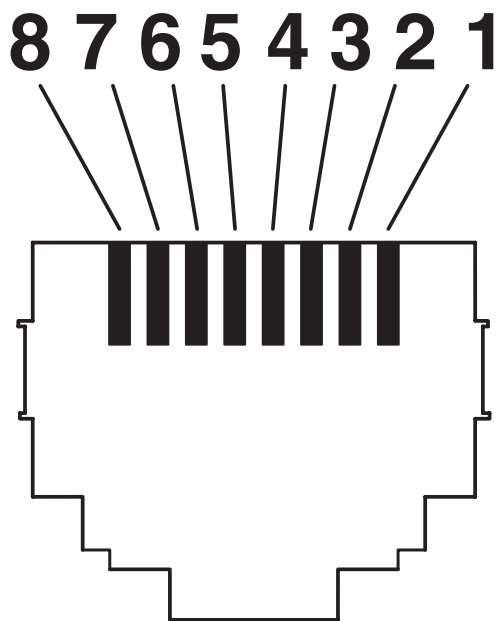

Connector pin assignment plug RJ45

1406117

<https://www.phoenixcontact.com/au/products/1406117>

Circuit diagram

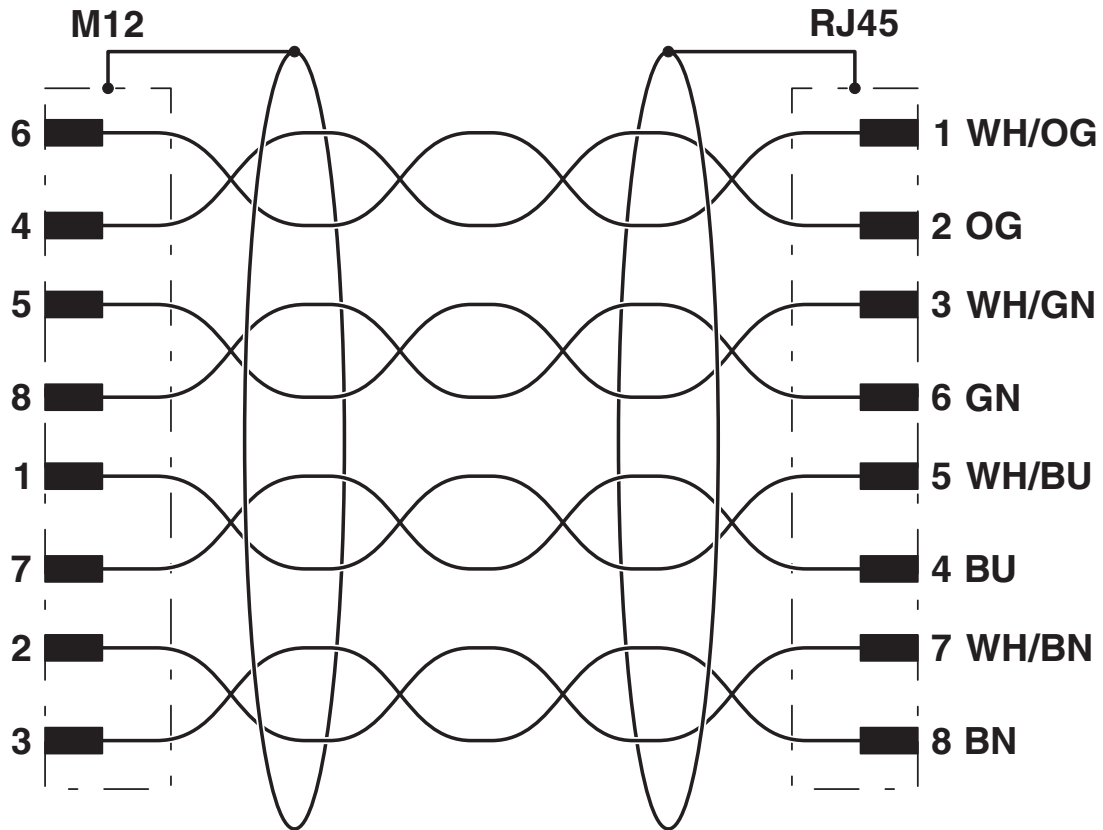

Contact assignment of the M12 and RJ45 plug

NBC-M12MS/ 2,0-94B/R4AC US - Network cable



1406117

<https://www.phoenixcontact.com/au/products/1406117>

Approvals

To download certificates, visit the product detail page: <https://www.phoenixcontact.com/au/products/1406117>

 UL Listed Approval ID: FILE E 335024	Nominal voltage U_N	Nominal current I_N	Cross section AWG	Cross section mm^2
	30 V	0.5 A	-	-

 EAC-RoHS Approval ID: RU D-DE.HB35.B.00387
--

1406117

<https://www.phoenixcontact.com/au/products/1406117>

Classifications

ECLASS

ECLASS-13.0

27060307

ETIM

ETIM 9.0

EC001855

UNSPSC

UNSPSC 21.0

26121600

NBC-M12MS/ 2,0-94B/R4AC US - Network cable



1406117

<https://www.phoenixcontact.com/au/products/1406117>

Environmental product compliance

EU RoHS

Fulfills EU RoHS substance requirements	Yes, No exemptions
---	--------------------

China RoHS

Environment friendly use period (EFUP)	EFUP-E
	No hazardous substances above the limits

EU REACH SVHC

REACH candidate substance (CAS No.)	No substance above 0.1 wt%
-------------------------------------	----------------------------

EF3.0 Climate Change

CO2e kg	2.342 kg CO2e
---------	---------------

Phoenix Contact 2025 © - all rights reserved
<https://www.phoenixcontact.com>

PHOENIX CONTACT PTY Ltd
Unit 7, 2-8 South Street
Rydalmere NSW 2116
1300 786 411
customerservice@phoenixcontact.com.au