

HC-STA-B32-HHFD-1STM32-EL-AL - Housing



1424836

<https://www.phoenixcontact.com/au/products/1424836>

Please be informed that the data shown in this PDF document is generated from our online catalog. Please find the complete data in the user documentation. Our general terms of use for downloads are valid.



Sleeve housing B32, for double locking latch, material: Die-cast aluminum, salt water resistant, cable outlets: 1, lateral, 1x M32, height: 94 mm, cable gland: none, Standard

Your advantages

- Good shielding in the event of electromagnetic interference

Commercial data

Item number	1424836
Packing unit	1 pc
Minimum order quantity	1 pc
Sales key	AF7APB
Product key	AF7APB
Catalog page	Page 644 (C-2-2019)
GTIN	4055626382418
Weight per piece (including packing)	439.6 g
Weight per piece (excluding packing)	425.6 g
Customs tariff number	85389099
Country of origin	CN

1424836

<https://www.phoenixcontact.com/au/products/1424836>

Technical data

Product properties

Product type	Housing with locking latch
Housing type	Sleeve housing
Application	Standard
Type	B32
No. of cable outlets	1
Type of the screw connection	1x M32
Type	Tall design
Cable outlet	lateral
Pg screw connection	none

Dimensions

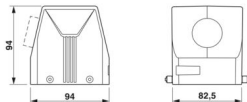
Dimensional drawing	
Width	82.5 mm
Height	94 mm
Length	94 mm

Material specifications

Housing material	Die-cast aluminum, salt water resistant
Housing surface material	uncoated

Mechanical properties

Mechanical data

Type of the screw connection	1x M32
Locking type	Pin

Environmental and real-life conditions

Ambient conditions

Degree of protection	IP66 IP67
Enclosure rating (NEMA)	4 (UL 50e) 4X (UL 50e) 12 (UL 50e)
Impact strength	IK09
Ambient temperature (operation)	-40 °C ... 125 °C

HC-STA-B32-HHFD-1STM32-EL-AL - Housing



1424836

<https://www.phoenixcontact.com/au/products/1424836>

Drawings

Dimensional drawing

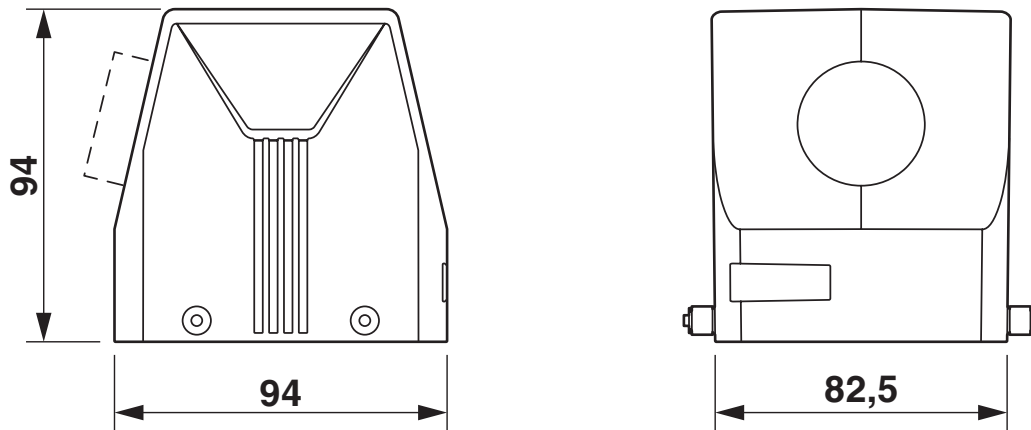

Dimensional drawing

1424836

<https://www.phoenixcontact.com/au/products/1424836>

Approvals

🔗 To download certificates, visit the product detail page: <https://www.phoenixcontact.com/au/products/1424836>

DNV

Approval ID: TAE000037S



cUL Recognized

Approval ID: E255026



UL Recognized

Approval ID: E255026

1424836

<https://www.phoenixcontact.com/au/products/1424836>

Classifications

ECLASS

ECLASS-13.0

27440202

ETIM

ETIM 9.0

EC000437

UNSPSC

UNSPSC 21.0

31261500

1424836

<https://www.phoenixcontact.com/au/products/1424836>

Environmental product compliance

EU RoHS

Fulfills EU RoHS substance requirements	Yes, No exemptions
---	--------------------

China RoHS

Environment friendly use period (EFUP)	EFUP-E
	No hazardous substances above the limits

EU REACH SVHC

REACH candidate substance (CAS No.)	No substance above 0.1 wt%
-------------------------------------	----------------------------

Phoenix Contact 2025 © - all rights reserved
<https://www.phoenixcontact.com>

PHOENIX CONTACT PTY Ltd
Unit 7, 2-8 South Street
Rydalmere NSW 2116
1300 786 411
customerservice@phoenixcontact.com.au