

# SAC-8P- 1,5-PUR/M 8FR - Sensor/actuator cable



1404191

<https://www.phoenixcontact.com/au/products/1404191>

Please be informed that the data shown in this PDF document is generated from our online catalog. Please find the complete data in the user documentation. Our general terms of use for downloads are valid.

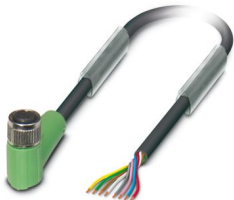

Sensor/actuator cable, 8-position, PUR halogen-free, black-gray RAL 7021, free cable end, on Socket angled M8, coding: A, cable length: 1.5 m

## Your advantages

- Easy and safe: 100 % electrically tested plug-in components
- Save space – with high-pos. connectors

## Commercial data

Item number	1404191
Packing unit	1 pc
Minimum order quantity	1 pc
Sales key	AF1BGA
Product key	AF1BGA
Catalog page	Page 207 (C-2-2019)
GTIN	4046356681131
Weight per piece (including packing)	53.228 g
Weight per piece (excluding packing)	51 g
Customs tariff number	85444290
Country of origin	PL

# SAC-8P- 1,5-PUR/M 8FR - Sensor/actuator cable



1404191

<https://www.phoenixcontact.com/au/products/1404191>

## Technical data

### Product properties

Product type	Sensor/actuator cable
Application	Standard
Number of positions	8
No. of cable outlets	1
Shielded	no
Coding	A

### Insulation characteristics

Degree of pollution	3
---------------------	---

### Material specifications

Flammability rating according to UL 94	HB
Material of grip body	TPU, hardly inflammable, self-extinguishing
Contact material	CuSn
Contact surface material	Ni/Au
Contact carrier material	TPU GF
Material for screw connection	Zinc die-cast, nickel-plated

### Electrical properties

Insulation resistance	≥ 100 MΩ
Nominal voltage $U_N$	30 V AC
	30 V DC
Nominal current $I_N$	1.5 A

### Mechanical properties

#### Mechanical data

Insertion/withdrawal cycles	≥ 100
-----------------------------	-------

### Signaling

Status display	no
Status display present	no

### Connection data

#### Conductor connection

Tightening torque	0.2 Nm (M8 connectors)
-------------------	------------------------

### Connector

#### Connection 1

Type	free cable end
------	----------------

# SAC-8P- 1,5-PUR/M 8FR - Sensor/actuator cable



1404191

<https://www.phoenixcontact.com/au/products/1404191>

## Connection 2

Type	Socket angled M8
Number of positions	8
Coding type	A

## Cable/line

Cable length	1.5 m
--------------	-------

## PUR halogen-free black [PUR]

Dimensional drawing	
Cable weight	31.4 kg/km
UL AWM Style	20549
Number of positions	8
Shielded	no
Cable type	PUR halogen-free black [PUR]
Conductor structure signal line	18x 0.10 mm
AWG signal line	26
Conductor cross section	8x 0.14 mm <sup>2</sup> (Signal line)
Wire diameter incl. insulation	1 mm ±0.02 mm (Signal line)
External cable diameter	5.10 mm ±0.15 mm
Outer sheath, material	PUR
External sheath, color	black-gray RAL 7021
Conductor material	Bare Cu litz wires
Material, filler	PE
Material wire insulation	PP
Single wire, color	white, brown, green, yellow, gray, pink, blue, red
Thickness, insulation	≥ 0.21 mm (Signal line) ≥ 0.38 mm (Outer cable sheath)
Overall twist	8 wires around filler to the core
Length of twist, overall twist	58 mm
Max. conductor resistance	139 Ω/km (at 20 °C)
Insulation resistance	1 GΩ*km (at 20 °C)
Nominal voltage, cable	≤ 300 V AC
Test voltage	≥ 3000 V AC (Spark test)
Minimum bending radius, fixed installation	5 x D
Minimum bending radius, flexible installation	10 x D
Smallest bending radius, fixed installation	25.5 mm

# SAC-8P- 1,5-PUR/M 8FR - Sensor/actuator cable



1404191

<https://www.phoenixcontact.com/au/products/1404191>

Smallest bending radius, movable installation	51 mm
Dynamic load capacity (bending)	Max. bending cycles: 4000000, Bending radius: 51 mm, Traversing path: 10 m, Traversing rate: 3 m/s, Acceleration: 10 m/s <sup>2</sup>
Halogen-free	in accordance with DIN VDE 0472 part 815
	in accordance with DIN EN 50267-2-1
Flame resistance	according to UL 758/1581 (horizontal)
	in accordance with UL 758/1581 FT2
Resistance to oil	According to DIN EN 60811-2-1, 168 h at 100°C
Other resistance	hydrolysis and microbe resistant
	Resistant to salt water
	Low adhesion
	abrasion-resistant
Ambient temperature (operation)	partly UV-resistant (in accordance with DIN EN ISO 4892-2-A)
	-40 °C ... 80 °C (cable, fixed installation)
	-25 °C ... 80 °C (Cable, flexible installation)

## Environmental and real-life conditions

### Ambient conditions

Degree of protection	IP65
	IP67
	IP68
Ambient temperature (operation) (male connector/female connector)	-25 °C ... 85 °C (Plug / socket)

## Standards and regulations

### M8

Standard designation	M8 connector
Standards/specifications	IEC 61076-2-104

# SAC-8P- 1,5-PUR/M 8FR - Sensor/actuator cable

1404191

<https://www.phoenixcontact.com/au/products/1404191>

## Drawings

Dimensional drawing

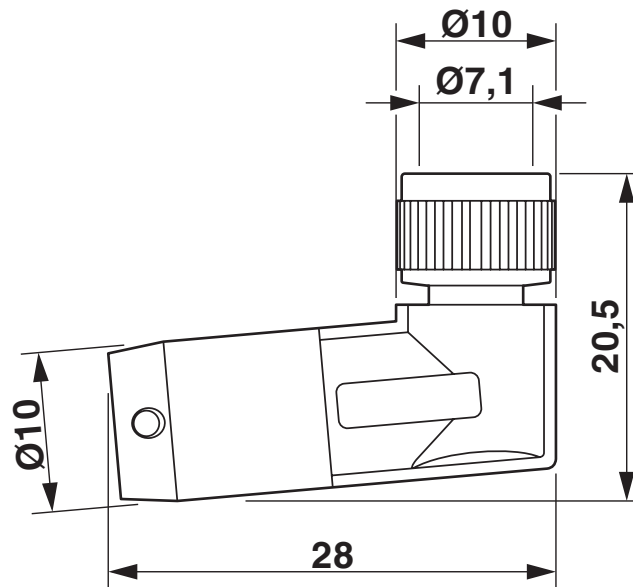

Socket M8 x 1, angled

Schematic diagram



Connector pin assignment of M8 socket, 8-pos., view of socket side

# SAC-8P- 1,5-PUR/M 8FR - Sensor/actuator cable



1404191

<https://www.phoenixcontact.com/au/products/1404191>

Circuit diagram

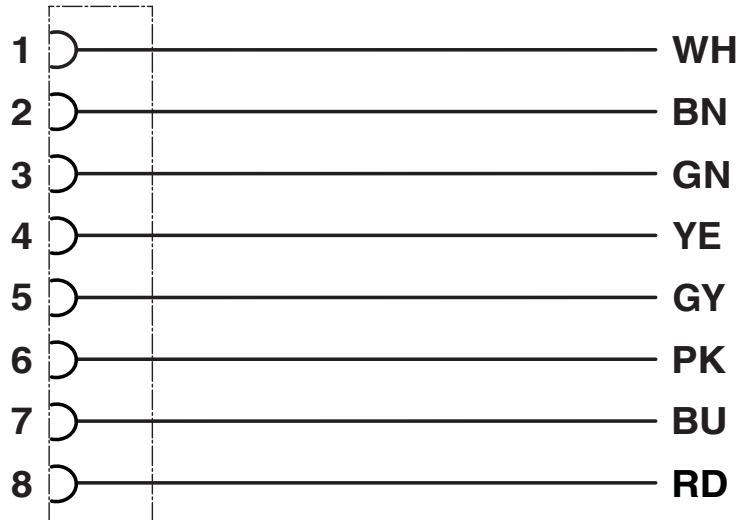

Contact assignment of M8 socket

# SAC-8P- 1,5-PUR/M 8FR - Sensor/actuator cable





1404191

<https://www.phoenixcontact.com/au/products/1404191>

## Approvals

To download certificates, visit the product detail page: <https://www.phoenixcontact.com/au/products/1404191>

 <b>UL Listed</b> Approval ID: FILE E 221474				
	Nominal voltage $U_N$	Nominal current $I_N$	Cross section AWG	Cross section $\text{mm}^2$
	30 V	1.5 A	-	-

 <b>cUL Listed</b> Approval ID: FILE E 221474				
	Nominal voltage $U_N$	Nominal current $I_N$	Cross section AWG	Cross section $\text{mm}^2$
	30 V	1.5 A	-	-

 <b>EAC-RoHS</b> Approval ID: RU D-DE.HB35.B.00387	
---	--

# SAC-8P- 1,5-PUR/M 8FR - Sensor/actuator cable



1404191

<https://www.phoenixcontact.com/au/products/1404191>

## Classifications

### ECLASS

ECLASS-13.0

27060311

### ETIM

ETIM 9.0

EC001855

### UNSPSC

UNSPSC 21.0

26121600

# SAC-8P- 1,5-PUR/M 8FR - Sensor/actuator cable



1404191

<https://www.phoenixcontact.com/au/products/1404191>

## Environmental product compliance

### EU RoHS

Fulfills EU RoHS substance requirements	Yes, No exemptions
---	--------------------

### China RoHS

Environment friendly use period (EFUP)	EFUP-E
	No hazardous substances above the limits

### EU REACH SVHC

REACH candidate substance (CAS No.)	No substance above 0.1 wt%
-------------------------------------	----------------------------

### EF3.0 Climate Change

CO2e kg	1.173 kg CO2e
---------	---------------

Phoenix Contact 2025 © - all rights reserved  
<https://www.phoenixcontact.com>

PHOENIX CONTACT PTY Ltd  
Unit 7, 2-8 South Street  
Rydalmere NSW 2116  
1300 786 411  
[customerservice@phoenixcontact.com.au](mailto:customerservice@phoenixcontact.com.au)